



Empire

DECORATIONS

"Master's material, Masters of materials"

PRODUCT CATALOG

About Us

Empire Decorations takes great pride in representing Çukurova Polistren Dekor from the Netherlands and introducing exquisite decor pieces suitable for both indoor and outdoor spaces across the Caribbean. Since its establishment in 2012, Çukurova Polistren Dekor has consistently demonstrated its excellence, continually enhancing its offerings with innovative and stunning decorative pieces.

We are committed to providing homeowners with the opportunity to elevate their living spaces affordably and sustainably. Our products are designed to be user-friendly, akin to LEGO blocks, enabling anyone to unleash their creativity and become a true designer. Moreover, we offer the flexibility for interior builders to utilize our products seamlessly in their projects.

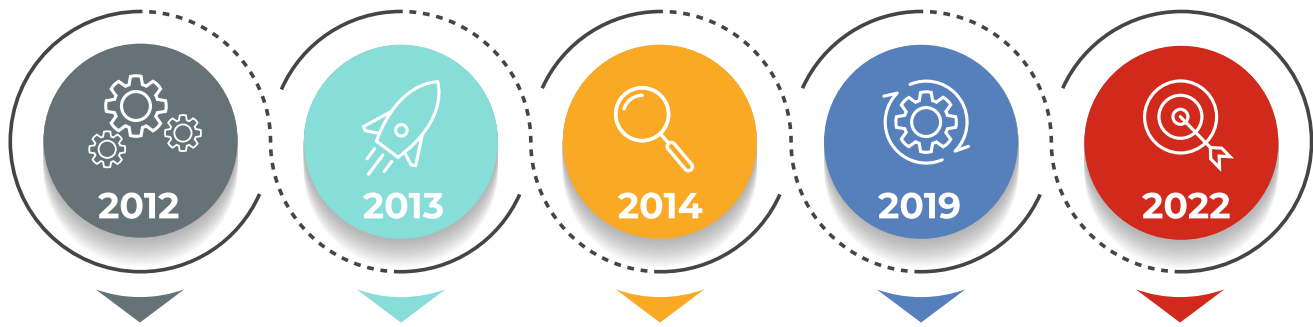

Start in Adana (Turkey) with a production hall of 2000m².

Rapidly became the favourite of numerous domestic and international consumers. Production hall scaled up to an impressive 7000m².

After a fire they managed to completely rebuild within 10 days and so continued to provide their services.

Following the significant success, a new factory was established.

Both domestic and international expansion continues to surge, buoyed by partnerships forged with global parties.

DESCRIPTION OF EPS

Expanded polystyrene hard foam is a petroleum-derived insulation material, composed of closed-cell foam thermoplastic. Known for its characteristic white color, this material provides effective insulation due to its closed pores.

The EPS (Expanded Polystyrene Hard Foam) product is created by expanding polystyrene particles using pentane gas and then bonding them together. This process results in the formation of foam. As the particles expand, small pores develop within the EPS. Subsequently, the pentane gas dissipates from the product, allowing air to fill the voids left behind. Thus, our EPS pieces consist of simplified structures, resembling stagnant air trapped within numerous closely packed porous cells (3.6 billion per cubic meter). 98% of the material is stagnant, dry air. The paramount concern is ensuring that production remains sustainable and minimally energy-intensive, despite the technical challenges. Apart from the mechanical strength, replacing the pentane gas with air also ensures that the product's performance remains stable throughout its lifespan. The thickness stays consistent, there is no increase in thermal conductivity, and the overall properties of the product do not deteriorate.

In the shaping phase, the last step in EPS production, the particles are blended together with precision to achieve a tight fusion. The high quality and successful execution of this process manifest in the honeycomb-like structures that become evident on the final product.

PLACES OF USE

Expanded polystyrene foam is commonly used to insulate sidewalls, terrace coverings, floors and basements against heat and cold. It is used for prefabricated building elements, commercial warehouses, expansion joints and rain gutters, cooling installations, glass packaging and further transportation of fragile products. Also used as molds in fisheries and for the overall decoration sector.

☎ +31 (0) 6 831 333 64

✉ info@empire-decorations.com

🌐 www.empire-decorations.com

🏠 Address to be announced, Aruba

Descripción de EPS El poliestireno expandido es una espuma asadasadura derivada del petróleo, un material aislante compuesto por termoplástico de células cerradas. Conocido por su característico color blanco, este material proporciona una eficaz aislamiento debido a sus poros cerrados.

El producto EPS (Espuma Rígida de Poliestireno Expandido) se crea expandiendo partículas de poliestireno utilizando gas pentano y luego uniéndolas entre sí. Este proceso resulta en la formación de espuma. A medida que las partículas se expanden, se desarrollan pequeños poros dentro del EPS. Posteriormente, el gas pentano se disipa del producto, permitiendo que el aire llene los espacios vacíos que deja atrás. Por lo tanto, nuestras piezas de EPS consisten en estructuras simplificadas, que se asemejan a aire estancado atrapado dentro de numerosas células porosas densamente empaquetadas (3.6 mil millones por metro cúbico). El 98% del material es aire estancado y seco. La preocupación principal es asegurar que la producción permanezca sostenible y con un mínimo consumo energético, a pesar de los desafíos técnicos. Además de la resistencia mecánica, reemplazar el gas pentano con aire también garantiza que el rendimiento del producto permanezca estable a lo largo de su vida útil. El grosor se mantiene constante, no hay aumento en la conductividad térmica y las propiedades generales del producto no se deterioran.

En la fase de conformación, el último paso en la producción de EPS, las partículas se mezclan con precisión para lograr una fusión sólida. La alta calidad y la exitosa ejecución de este proceso se manifiestan en las estructuras similares a panal de abeja que se hacen evidentes en el producto final.

Lugares de aplicación La espuma de poliestireno expandido se utiliza comúnmente para aislar paredes laterales, cubiertas de terrazas, pisos y sótanos contra el calor y el frío. Se utiliza para elementos de construcción prefabricados, almacenes comerciales, juntas de expansión y canalones, instalaciones de refrigeración, envases de vidrio y para el transporte de productos frágiles. También se utiliza como moldes en la pesca y en el sector de la decoración en general.

Beschrijving van EPS Uitgebreid polystyreen hard schuim is een isolatiemateriaal afgeleid van aardolie, samengesteld uit thermoplastisch schuim met gesloten cellen. Bekend om zijn kenmerkende witte kleur, biedt dit materiaal effectieve isolatie vanwege zijn gesloten poriën.

Het EPS (Expanded Polystyrene Hard Foam) product wordt gecreëerd door het expanderen van polystyreendeeltjes met behulp van pentaangas en ze vervolgens aan elkaar te binden. Dit proces resulteert in de vorming van schuim. Naarmate de deeltjes uitzetten, ontwikkelen zich kleine poriën binnen het EPS. Vervolgens vervliegt het pentaangas uit het product, waardoor lucht de achtergebleven holtes kan vullen. Onze EPS-stukken bestaan dus uit vereenvoudigde structuren, die lijken op stilstaande lucht die gevangen zit binnen talloze dicht op elkaar gepakte poreuze cellen (3,6 miljard per kubieke meter). 98% van het materiaal is stilstaande, droge lucht. De belangrijkste zorg is ervoor te zorgen dat de productie duurzaam blijft en minimaal energie-intensief, ondanks de technische uitdagingen. Afgezien van de mechanische sterkte zorgt het vervangen van het pentaangas door lucht er ook voor dat de prestaties van het product stabiel blijven gedurende de levensduur ervan. De dikte blijft consistent, er is geen toename in thermische geleidbaarheid en de algehele eigenschappen van het product verslechteren niet.

In de vormfase, de laatste stap in de EPS-productie, worden de deeltjes nauwkeurig samengevoegd om een strakke fusie te bereiken. De hoge kwaliteit en succesvolle uitvoering van dit proces manifesteren zich in de honinggraatachtige structuren die zichtbaar worden op het eindproduct.

Toepassingsgebieden Uitgebreid polystyreenschuim wordt veel gebruikt om zijwanden, terrasbedekkingen, vloeren en kelders te isoleren tegen warmte en kou. Het wordt gebruikt voor prefab bouwelementen, commerciële magazijnen, dilatatievoegen en regenafvoeren, koelinstallaties, glasverpakkingen en verdere transport van breekbare producten. Het wordt ook gebruikt als mallen in de visserij en voor de algemene decoratiesector.

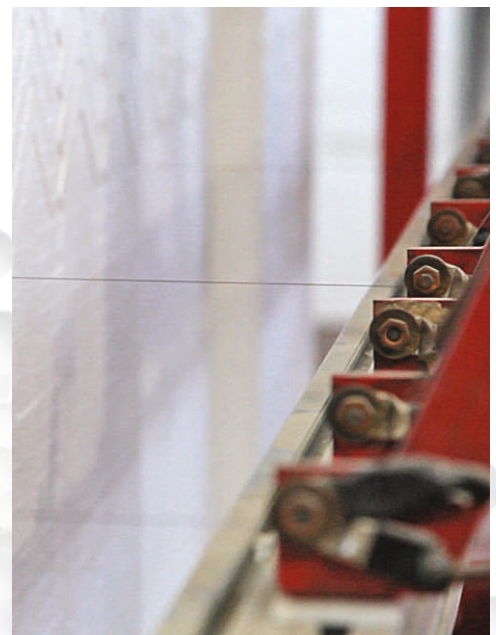
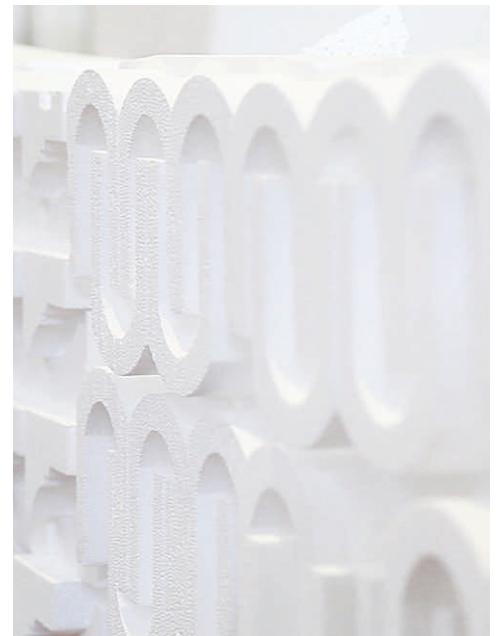

Interior Products

Productos Interiores

Cornice <i>Cornisa</i>	4-8	Fireplace <i>Chimenea</i>	17
Flat Plinth Molding <i>Moldura de Rodapé</i>	9	Wall Motif <i>Motivo de Pared</i>	18-27
XPS Curtain Cornice <i>Cornisa para Cortinas</i>	9	EPS Cornice <i>Cornisa de EPS</i>	28-29
LED Cornice <i>Cornisa de LED</i>	10-12	Corner Moldings <i>Esquineros</i>	30
Suspended Illuminated Ceiling <i>Techo Suspendido Iluminado</i>	13-15	Ceiling Rosette <i>Roseta de Techo</i>	32-33
TV Units <i>Muebles de Televisión</i>	16	Ceiling Panels <i>Paneles de Techo</i>	32-35

Exterior Products

Productos Exteriores

Door and Window Frame <i>Marco de Puerto y Ventana</i>	38-42	Pillars and Bases <i>Pilares y Bases</i>	64-70
Crown Molding <i>Moldura de Cornisa</i>	43-44	Buttress <i>Contrafuerte</i>	72-73
Facade Medallion <i>Medallón de Fachada</i>	46-47	Keystone <i>Piedra Angular</i>	74
Windowsill <i>Alféizar</i>	48-49	Ornament <i>Ornamento</i>	76
Floorstringer <i>Larguera de Piso</i>	50-54	Motif <i>Motivo Decorativo</i>	77-79
Fence Cover <i>Cubierta de Valla</i>	55	Wall Covering <i>Revestimiento de Pared</i>	82-86
Round Window Frame <i>Marco de Ventana Redonda</i>	55	Brick Coating <i>Revestimiento de Ladrillo</i>	88
Balustrade <i>Balaustrada</i>	55	Wall Covering <i>Revestimiento de Pared</i>	88
Baseboard Strip <i>Tira de Zócalo</i>	56-57	Mounting Glue <i>Pegamento de Montaje</i>	90
LED Product <i>Producto de LED</i>	58-59	Mounting Accesories <i>Accesorios de Montaje</i>	91
Corner Elements <i>Elementos de Esquina</i>	60-61	Insulation <i>Insulación</i>	92
Drainpipe Casing <i>Revestimiento de Drenaje</i>	62	Window and Door Models <i>Modelos de Ventana y Puerta</i>	94-95

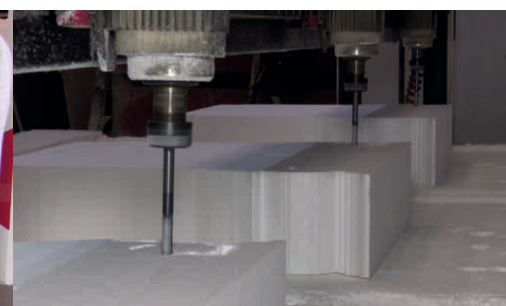

Empire

DECORATIONS

Interior Facades

Fachadas Interiores
Indoor Gevelproducten

All the products are manufactured with high density EPS and XPS.

Todos los productos se fabrican con EPS y XPS de alta densidad.

Alle producten worden vervaardigd met hoogwaardig EPS en XPS met hoge dichtheid.

Long Lasting



Sostenible

Best Quality



Mejor Calidad

Easy Montage



Montaje fácil





CKP 17

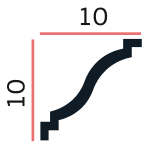

CKP 23



CKP 18

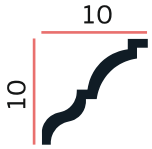

CKP 24

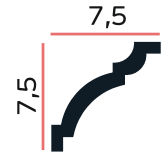

CKP 19

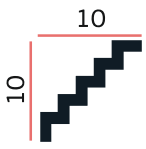

CKP 25

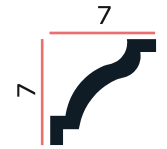

CKP 20

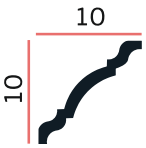

CKP 26

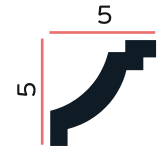

CKP 21

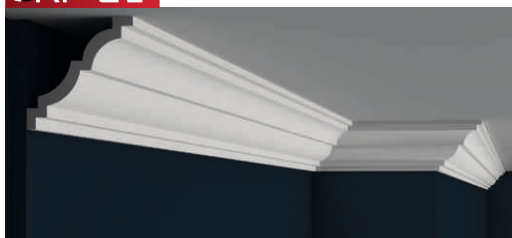
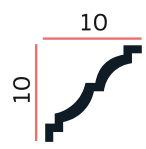

CKP 27

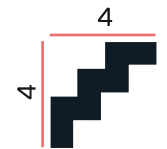

CKP 22

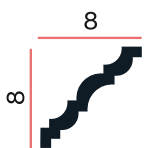

CKP 28

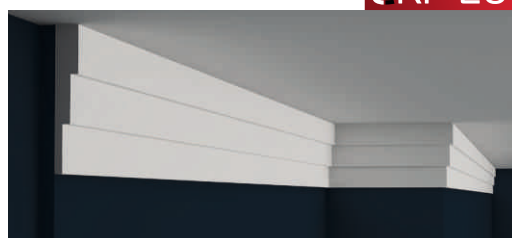

CKP 29



CKP 40

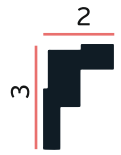

CKP 35

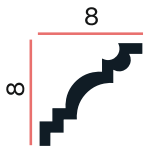

CKP 41

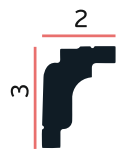

CKP 36

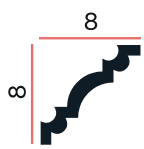

CKP 42

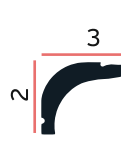

CKP 37

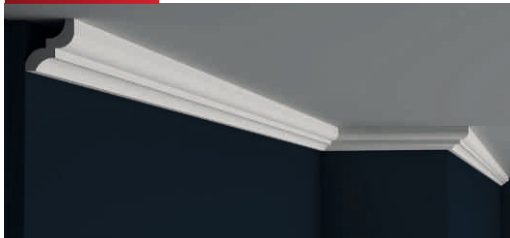
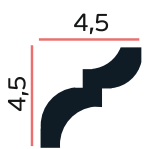

CKP 45

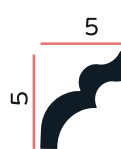

CKP 38

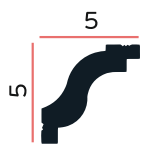

CKP 46

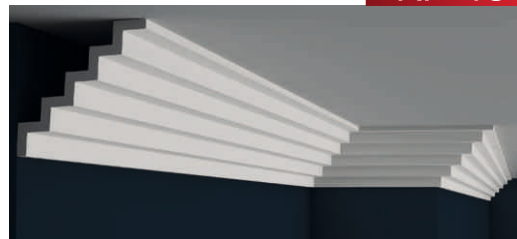
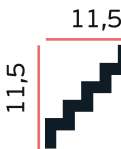

CKP 39

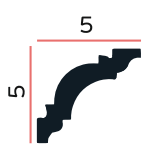

CKP 47

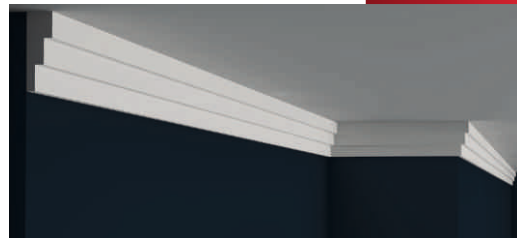
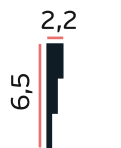



CKP 66

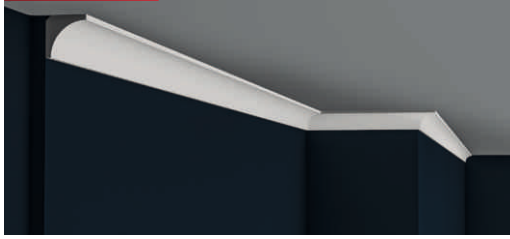
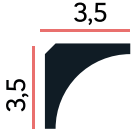

CKP 72



CKP 67

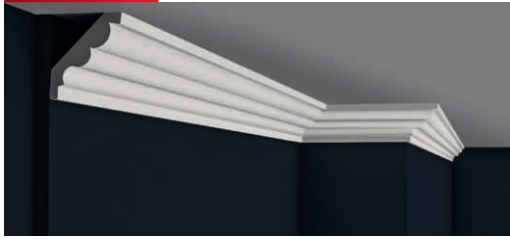
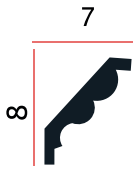

CKP 73

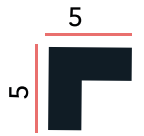

CKP 68

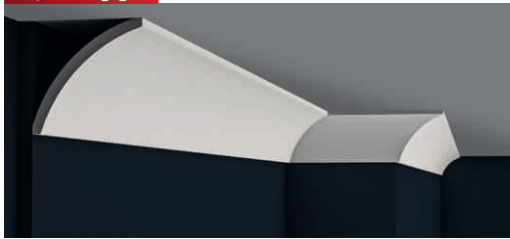
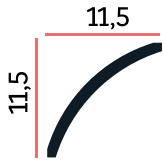

GLUE OF THE BEST
QUALITY

Cukurova[®]
polistren decoratie

OWN BRAND

CKP 69

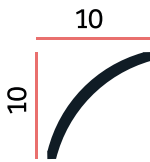

CKP 70



CKP 71



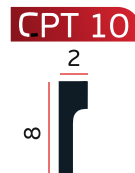
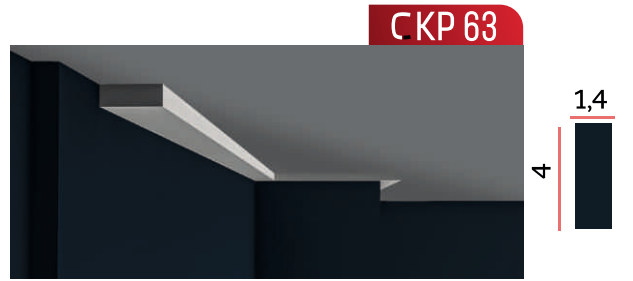

CIB02



CIB08

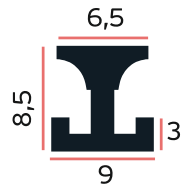

CIB03

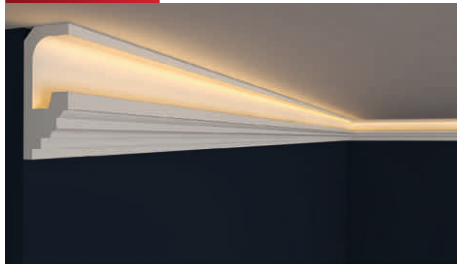

CIB09

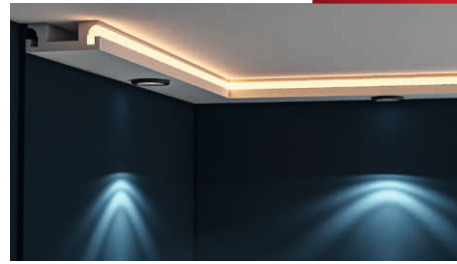

CIB04

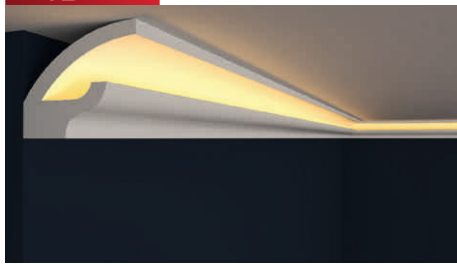
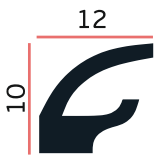

CIB10

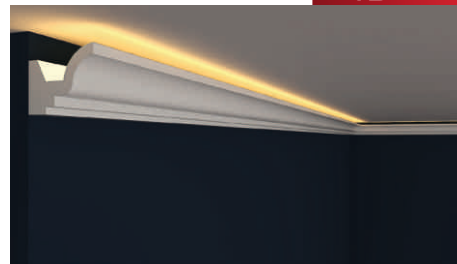
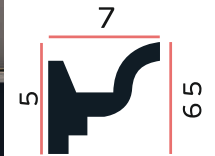

CIB05

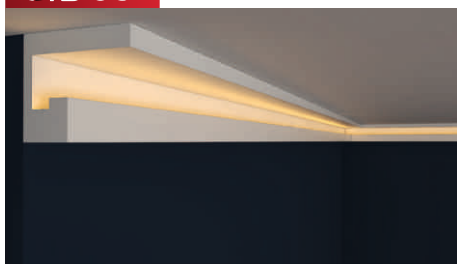
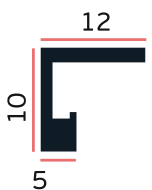

CIB11

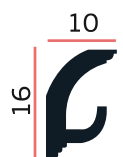

CIB07

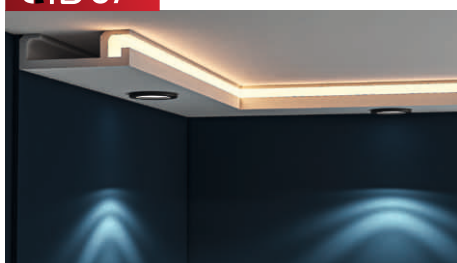
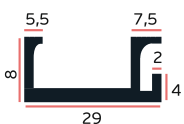

CIB12

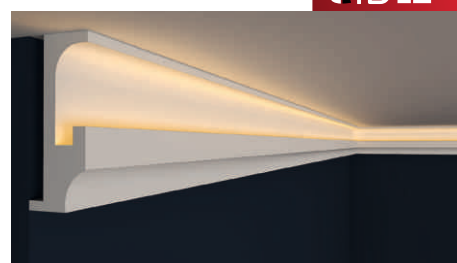

CIB13



CIB18



CIB15

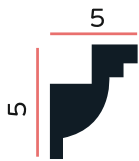

CIB19

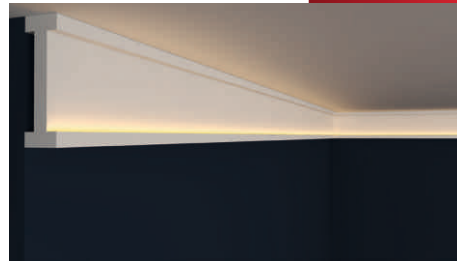

CIB16

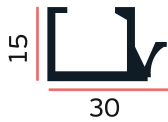

CIB20

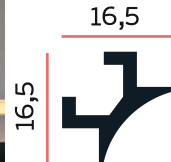

CIB17



CIB 21

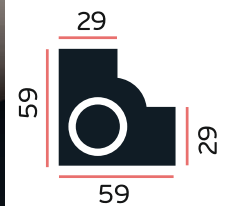

Add a luxurious touch to your room with LED Ready Cornices

Our LED cornices boast durability, lightweight construction, flexibility, repaintability, effortless installation, and resilience against breakage or detachment. Crafted from flame-retardant natural resources, our products ensure both safety and longevity.



**Affordable ceilings featuring
LED Polystyrene Cornice Molding**



CAT 01

15x150x150 cm

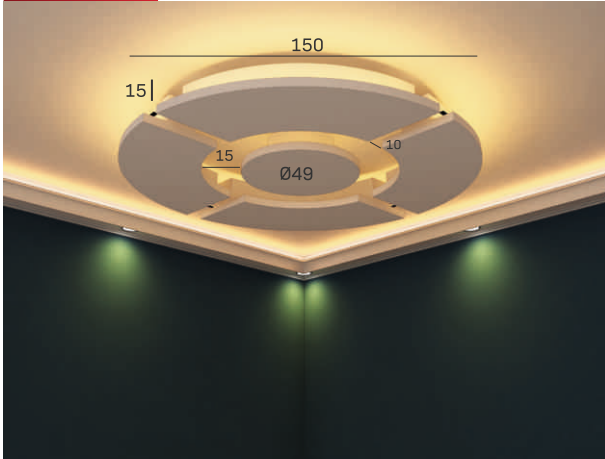

CAT 03

15x128x128 cm

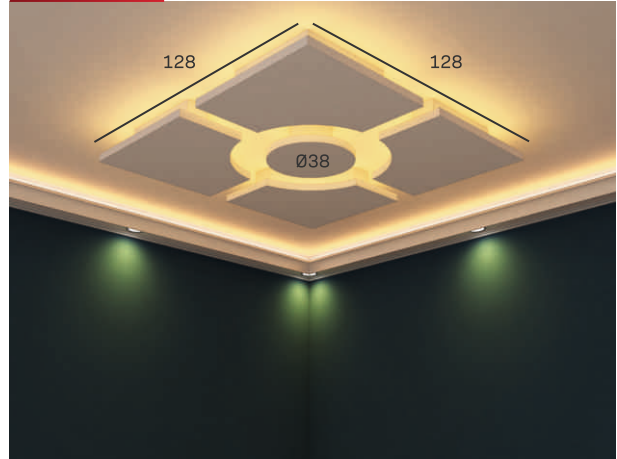

CAT 02

15x128x128 cm



CAT 04

15x150x150 cm

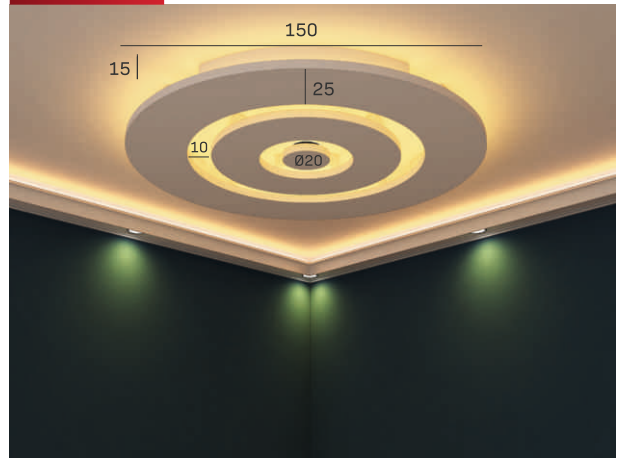

Our products are produced with
raw XPS-material
(extruded polystyrene)
with a high density!



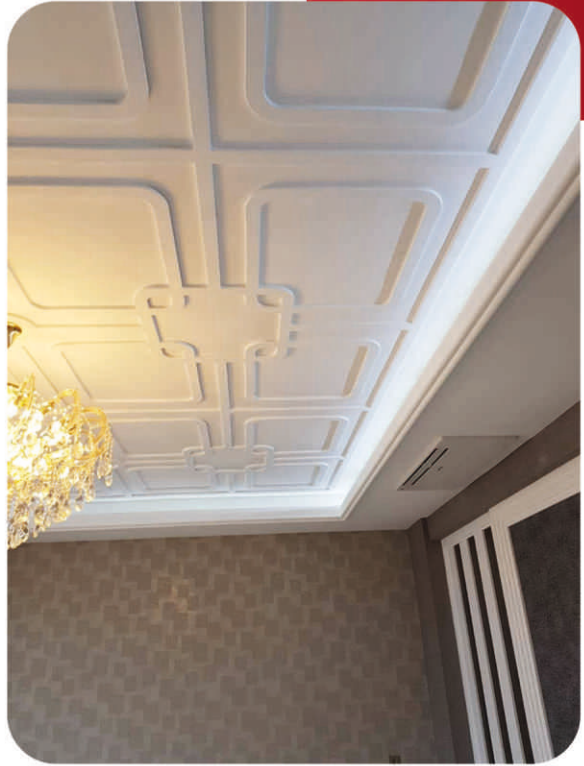



CTV 01 15x210x230 cm



CTV 04 15x200x250 cm



CTV 02 15x200x270 cm

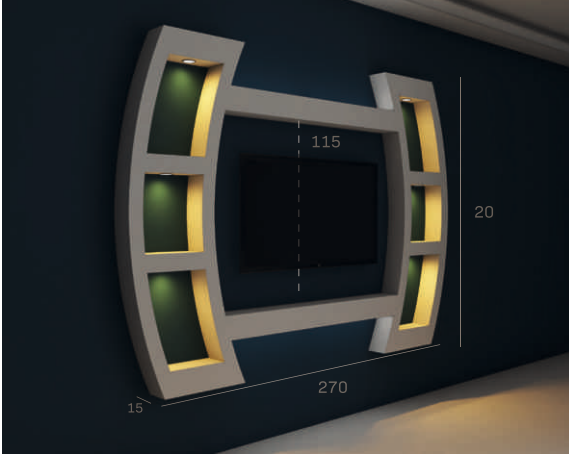

CTV 05 15x200x250 cm

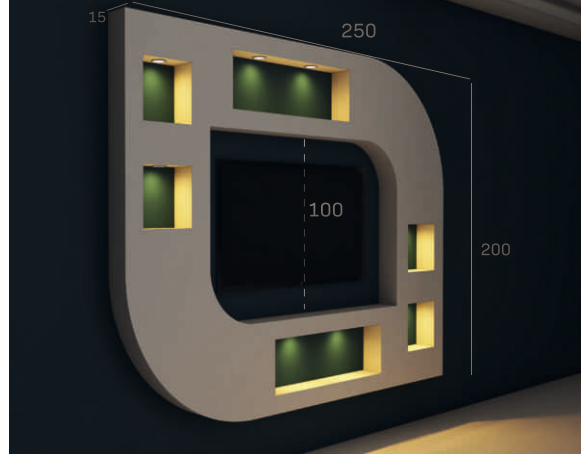

CTV 03 15x230x260 cm

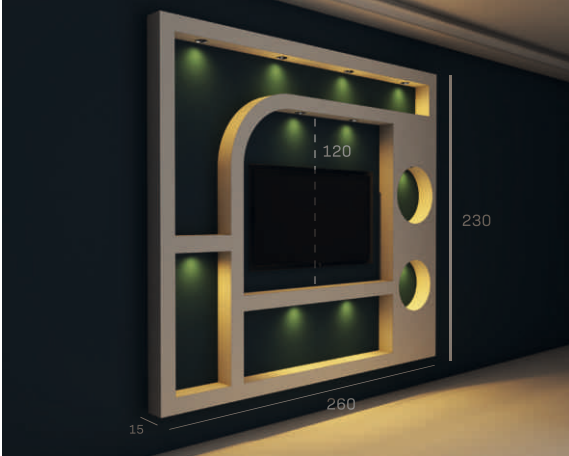

CTV 06 15x200x220 cm



CSM 01



CSM 03

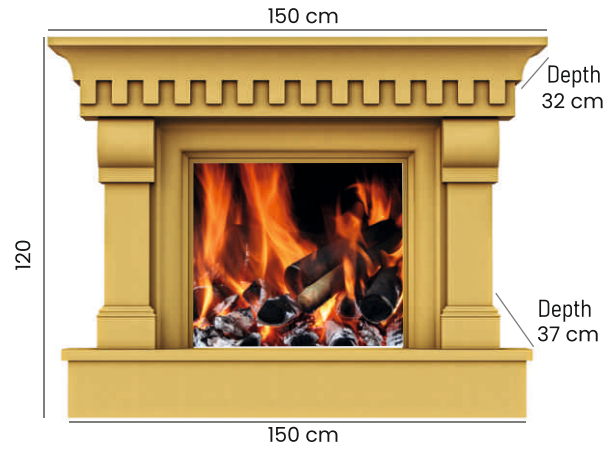

CSM 02

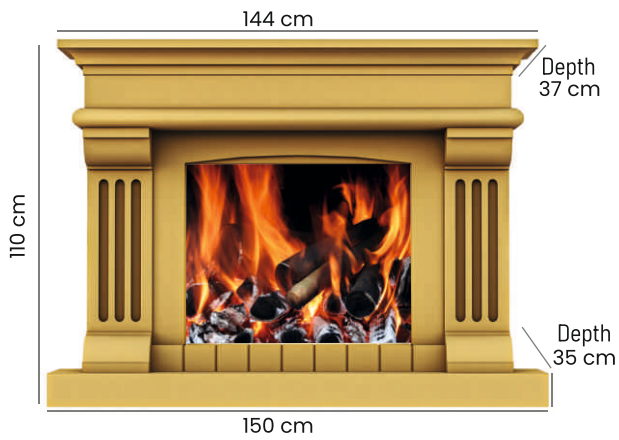

CSM 04

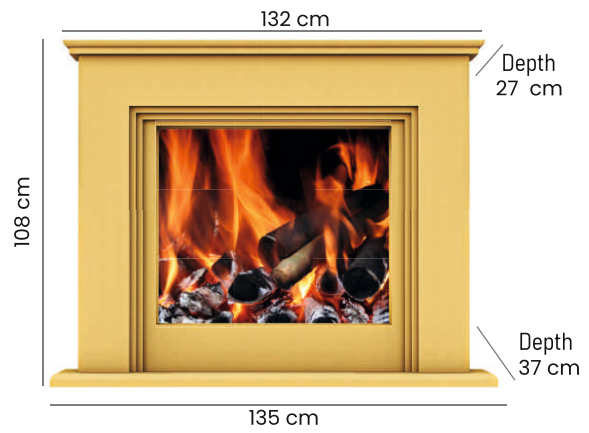

CiM 01

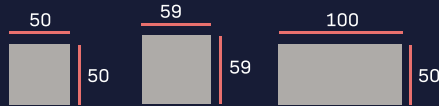

100 cm



50 cm

Thickness of our product is 1,4 cm

CiM 02

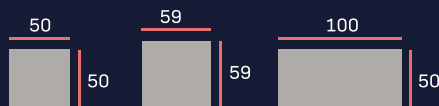

100 cm



50 cm

CiM 03

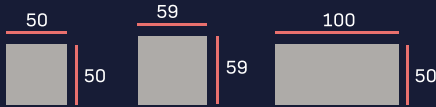

100 cm

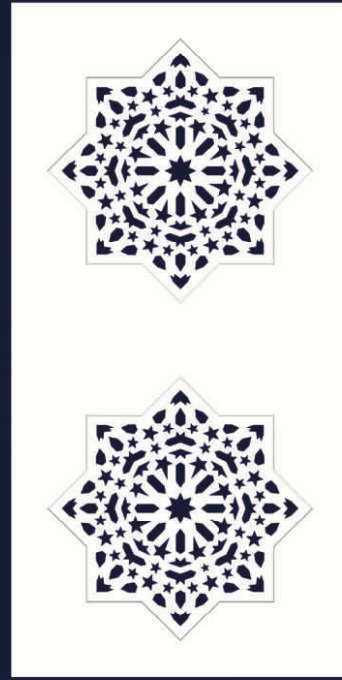

50 cm

CiM 04

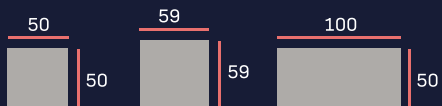

100 cm



50 cm

CiM 05

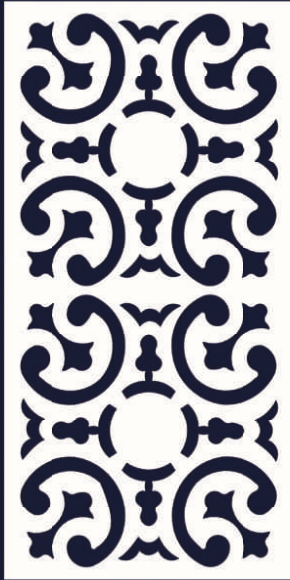

1,4x50x100 cm

CiM 06



1,4x50x100 cm

CiM 07



1,4x50x100 cm

CiM 08



1,4x50x100 cm

CiM 09



1,4x50x100 cm

CiM 10



1,4x50x100 cm

CiM 11



1,4x105 cm

CiM 12

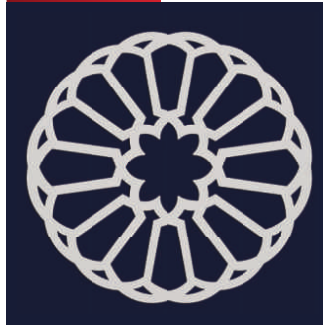

1,4x105 cm
1,4x160 cm

CiM 16

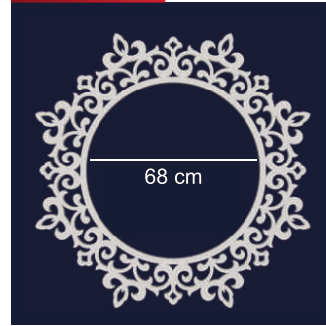

1,4x115 cm

CiM 17



1,4x110 cm

CiM 38



1,4x59x59 cm

CiM 39



1,4x59x65 cm

CiM 40

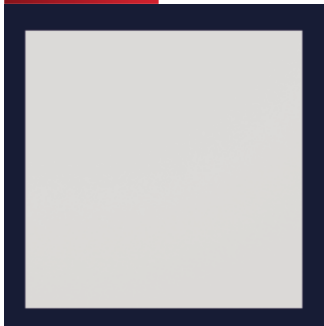

0,5x50x50 cm
0,5x59x59 cm
0,5x50x100 cm

CiM 41

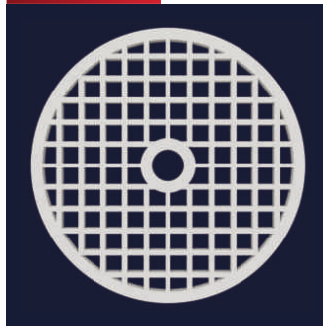

1,4x59 cm

CiM 42



1,4x50x50 cm
1,4x59x59 cm

CiM 43

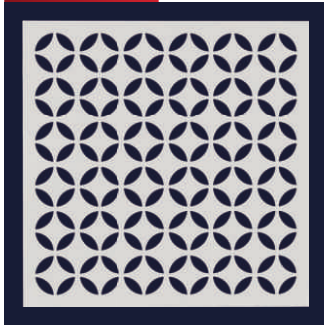

1,4x59x59 cm

CiM 44

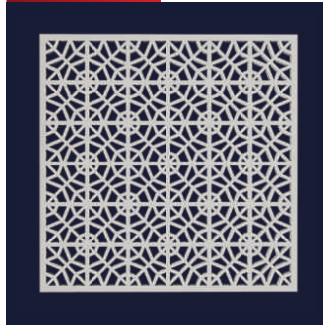

1,4x59x59 cm

CiM 45

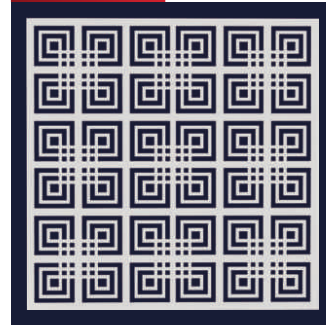

1,4x59x59 cm

CiM 19

1,4x58x198 cm

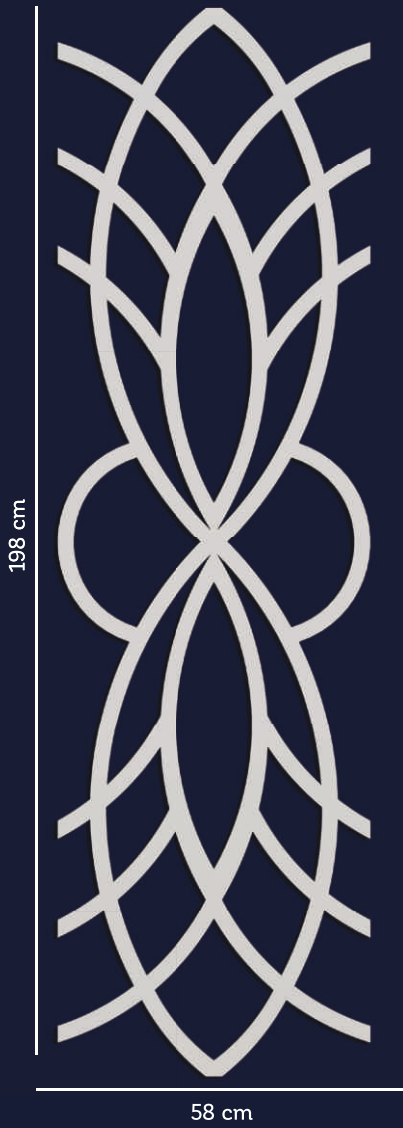

CiM 20

2x185x315 cm



CiM 22

2x150x390 cm

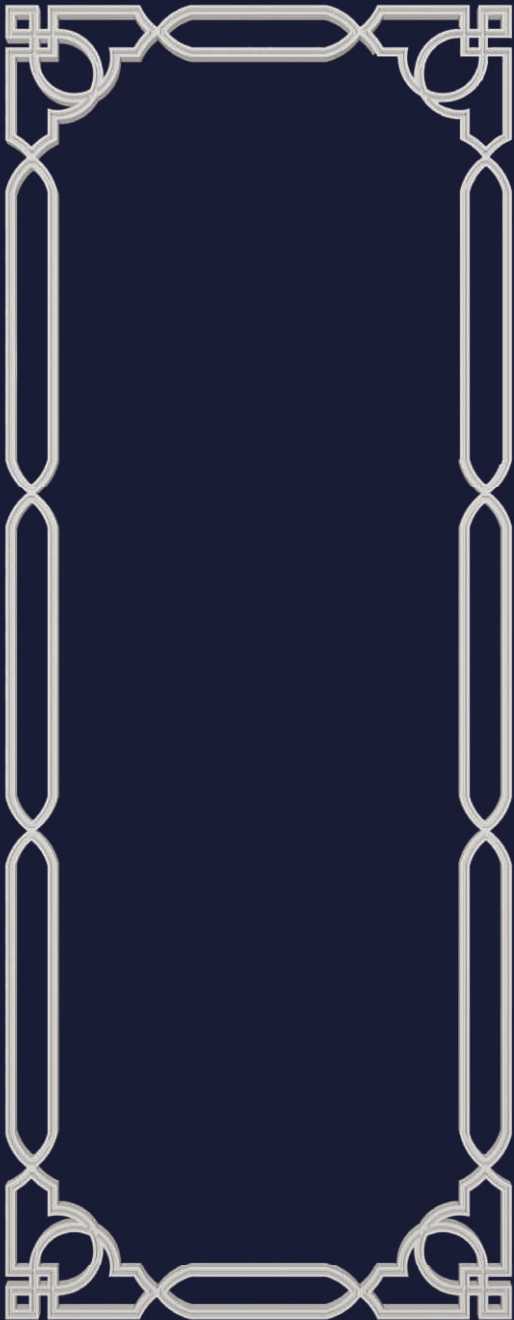

CiM 23

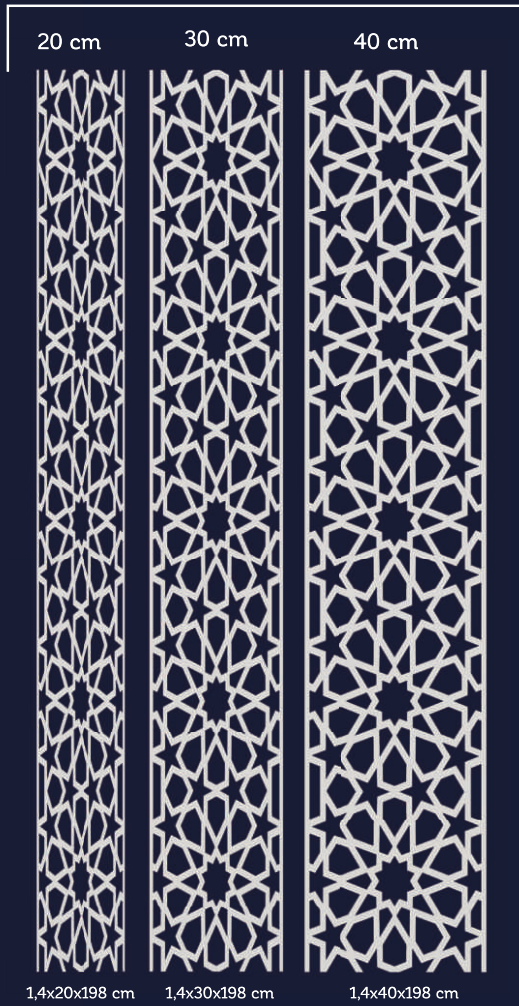

CiM 24

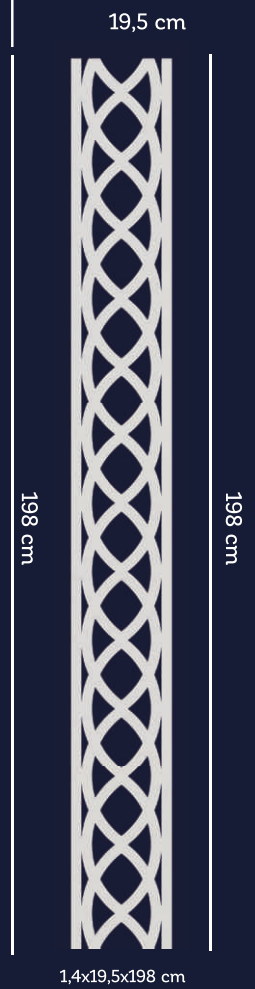

CiM 25

1,4x90x198 cm
1,4x58x198 cm



CiM 26

1,4x58x174 cm



CiM 27

1,4x90x198 cm

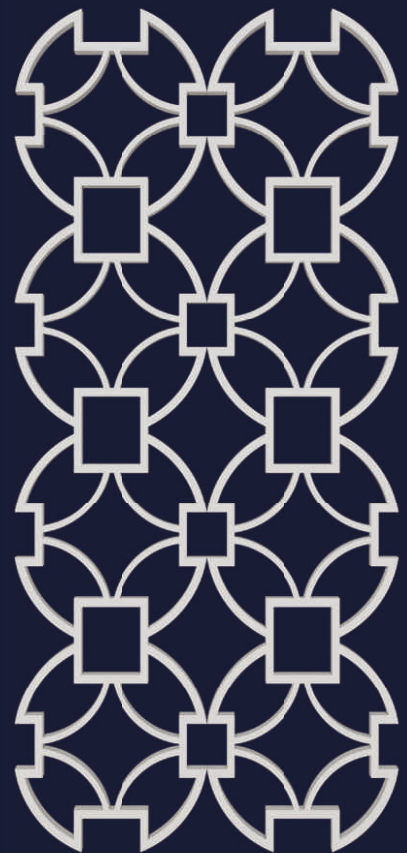

CiM 32

1,4x50x198 cm

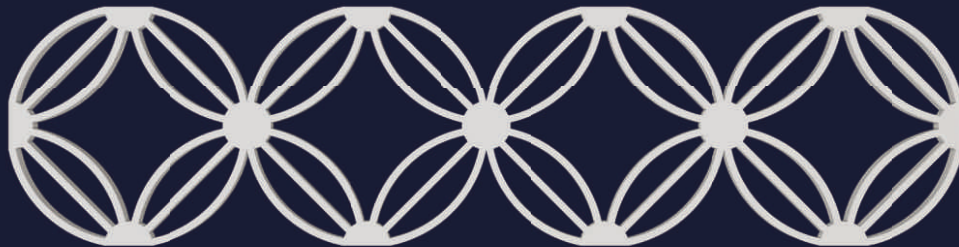

CiM 33

1,4x180x273 cm



CiM 31

1,4x119x255 cm



CiM 34

1,4x80x150 cm

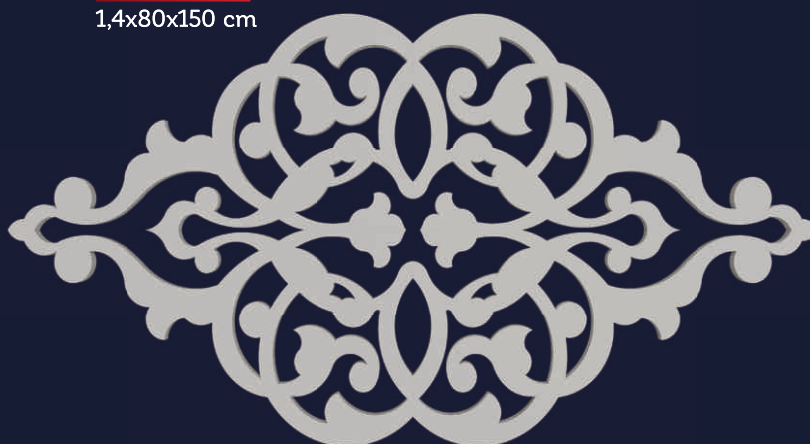

CiM 28



1,4x34x34 cm

CiM 29



1,4x44x80 cm

CiM 30



1,4x34x34 cm

CiM 35



1,4x34x34 cm

CiM 36



1,4x34x34 cm

CiM 37



1,4x34x34 cm

CiM 13

1,4x110 cm
1,4x150 cm
1,4x190 cm

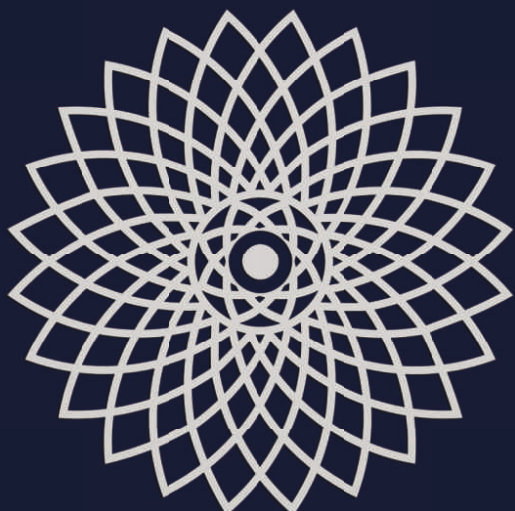

CiM 14

1,4x150 cm
1,4x200 cm
1,4x300 cm



CiM 18

6,5x59 cm



CiM 21

4,5x150 cm

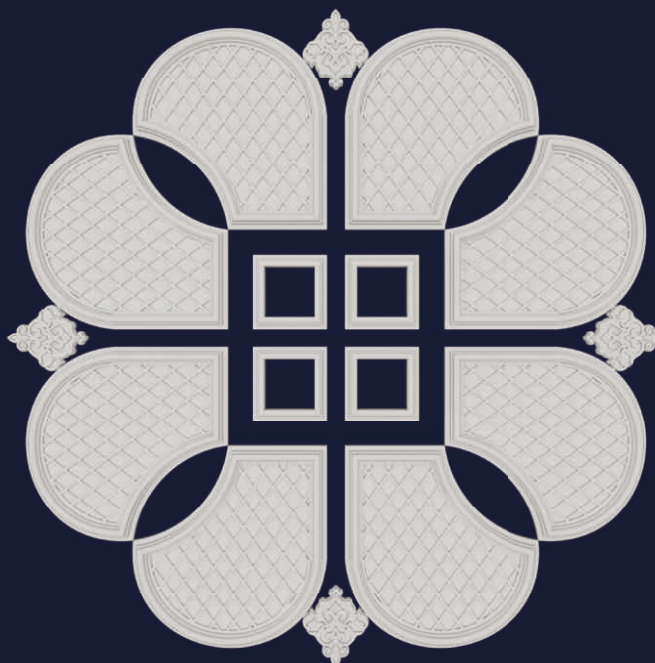

CEDK 02

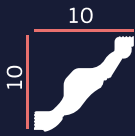

CEDK 03



CEDK 06



CEDK 10



CEDK 11



CEDK 12



CEDK 13



CEDK 14



CEDK 17



CEDK 18



CEDK 19



CEDK 21



CEDK 22



CEDK 23



CEDK 24



CEDK 25



CEDK 27



CEDK 28



CDÇ 01



CDÇ 02



CDÇ 03



CDÇ 04



CDÇ 05



CDÇ 06



ÇÇK 01



ÇÇK 02



ÇÇK 03



ÇÇK 04



ÇÇK 05



ÇÇK 06



ÇÇK 07



ÇÇK 08



New
Models
Coming
Soon!

Scan the QR-Code and take a look at our projects and unique designs!

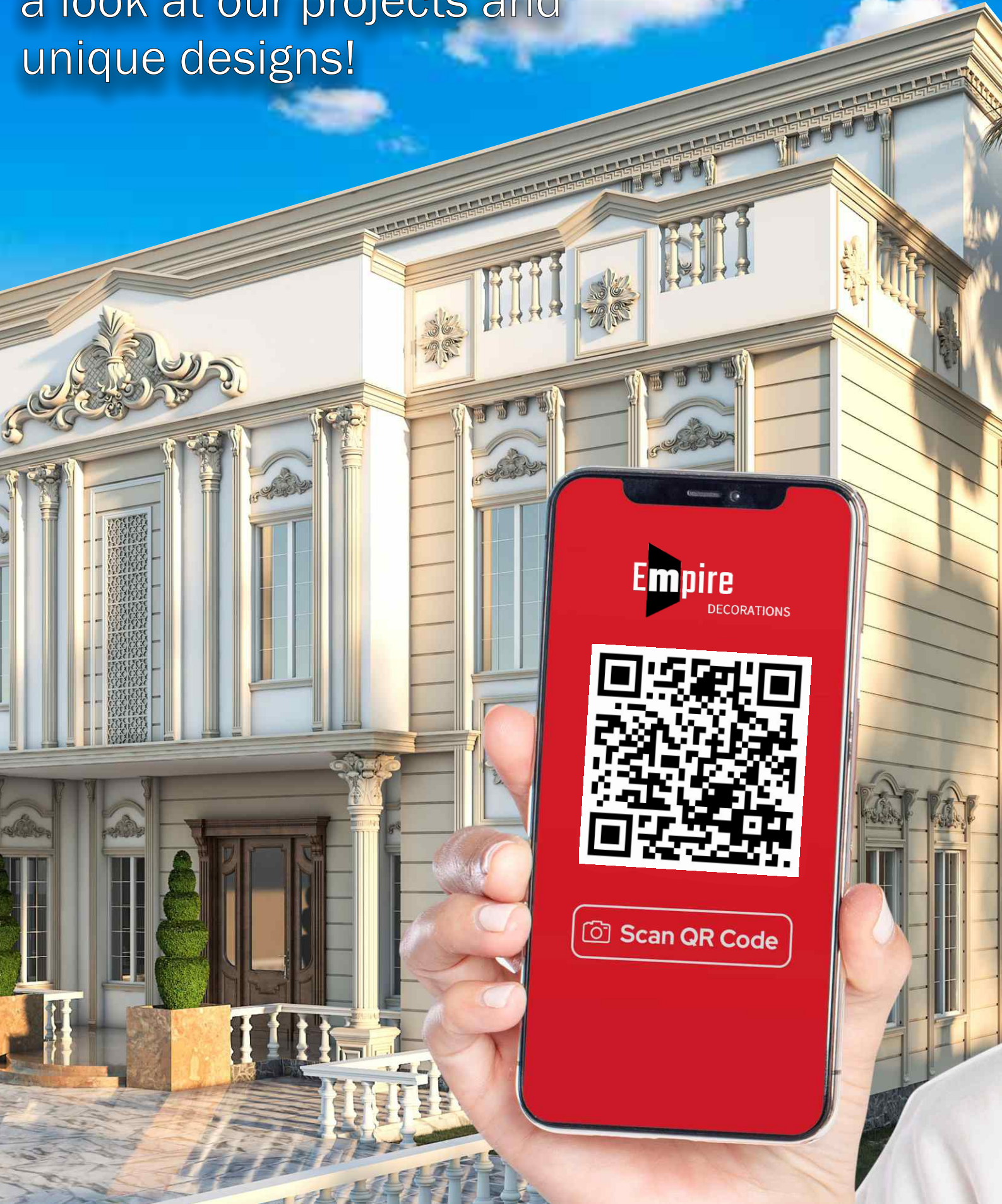

CGB 01

Ø39

Ø47

Ø55



CGB 02

Ø39

Ø47



CGB 03

Ø39

Ø47



CGB 04

Ø39

Ø47



CGB 05

Ø39

Ø47



CGB 07

Ø47
Ø55
Ø70



CGB 08

Ø55



CGB 09

Ø70



CGB 11

Ø55



CGB 10

Ø70



CGB 12

Ø70



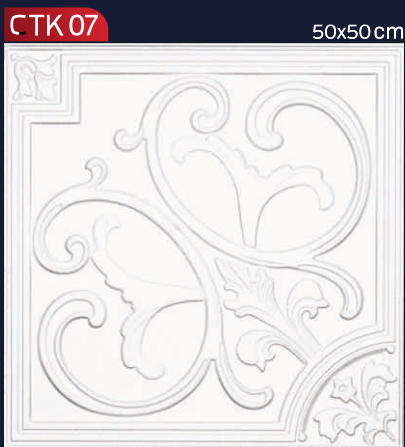
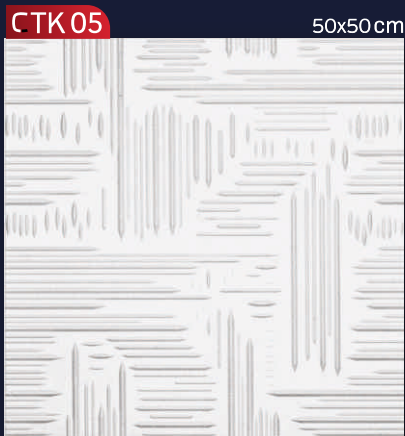
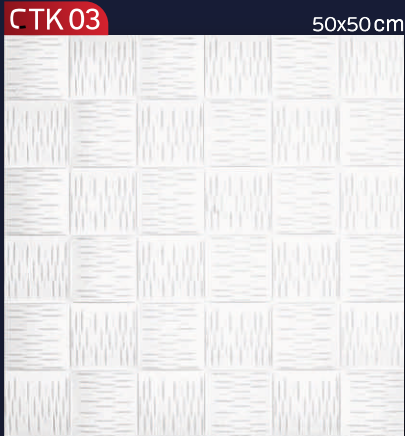
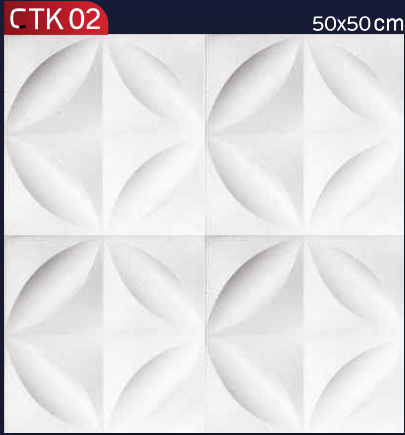

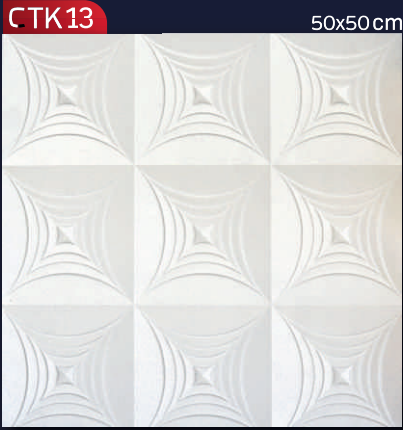
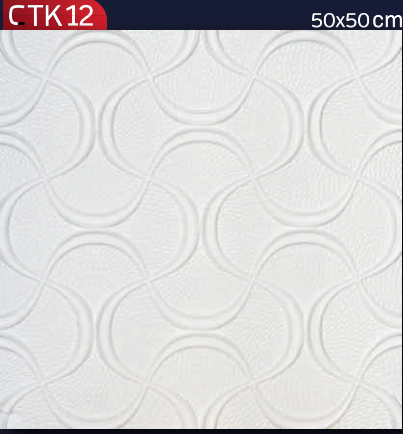

THE BEST WAY
OF APPLYING YOUR
CEILING PANELS IS
WITH **CYRD-10**



Empire

DECORATIONS

“Master’s Material,
Masters of Material”



Empire

DECORATIONS

Exterior Facades

Fachadas Exteriores
Outdoor Gevelproducten

High-density EPS (Expanded Polystyrene) products are crafted through shaping polystyrene, followed by the application of acrylic-based resin formed by blending various chemicals.

Los productos de EPS (poliestireno expandido de alta densidad) se elaboran mediante el moldeo de poliestireno, seguido por la aplicación de resina acrílica formada por la mezcla de varios productos químicos.

Hoogwaardige EPS (Geëxpandeerd Polystyreen) producten worden geproduceerd door eerst polystyreen te vormen en vervolgens een op acryl gebaseerde hars aan te brengen die is samengesteld uit verschillende chemicaliën.

Long Lasting



Sostenible

Best Quality



Mejor Calidad

Easy Montage



Montaje Fácil

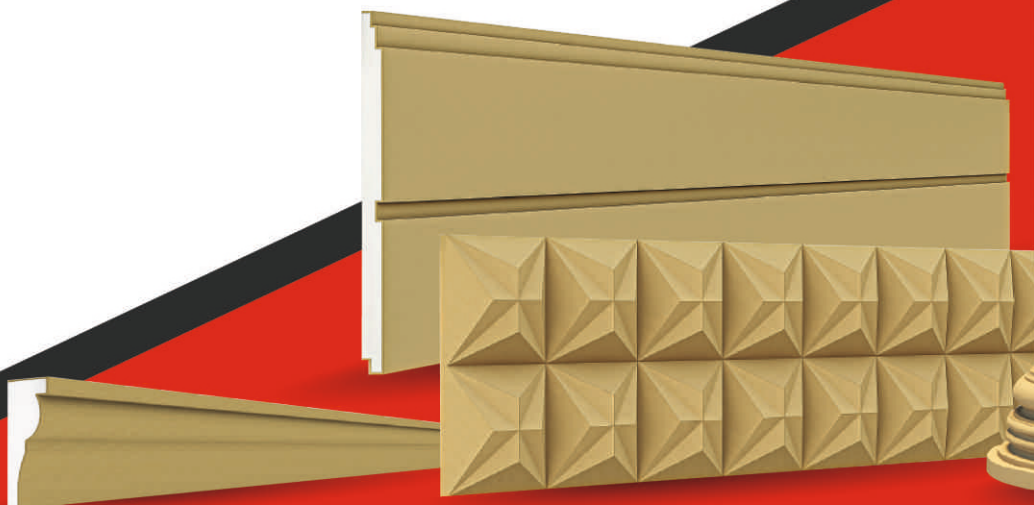
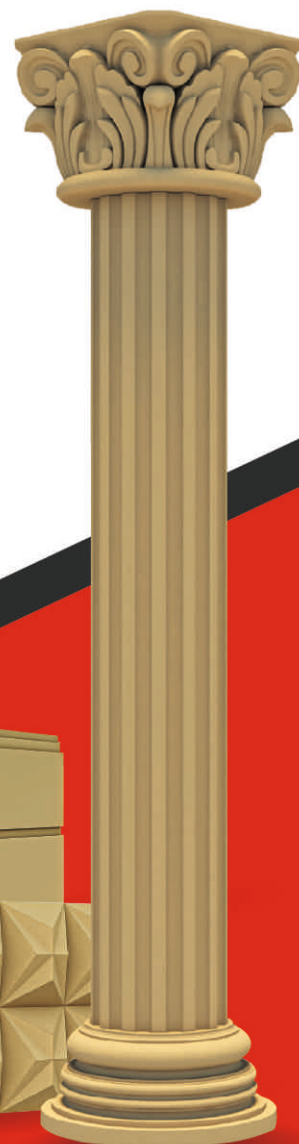

CSV 01

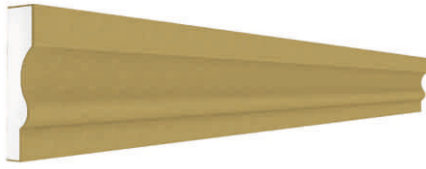

CSV 09



CSV 02

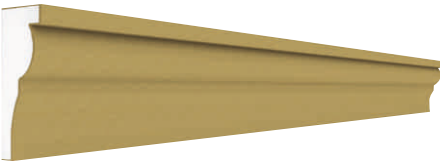

CSV 10

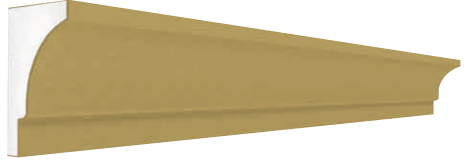

CSV 03

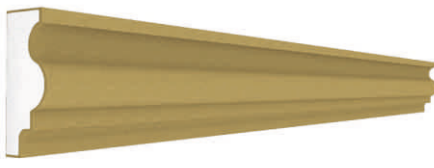

CSV 11

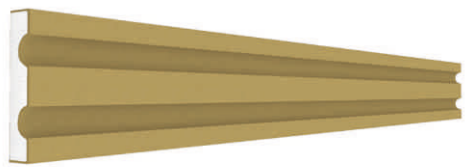

CSV 04

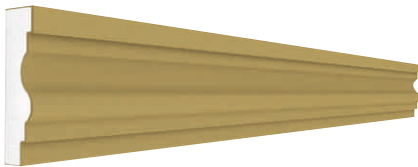

CSV 12

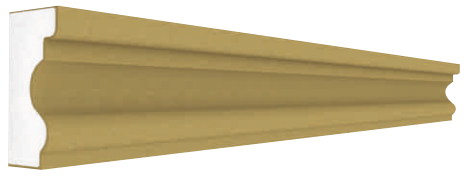

CSV 05

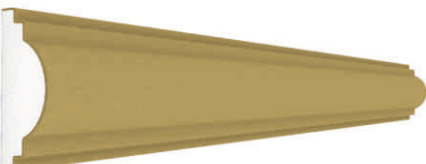

CSV 13

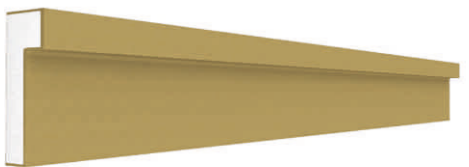

CSV 06

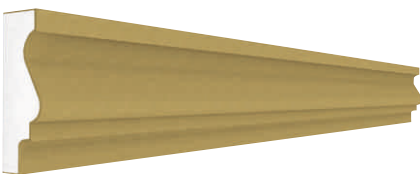

CSV 14

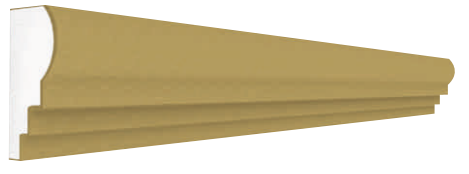

CSV 07

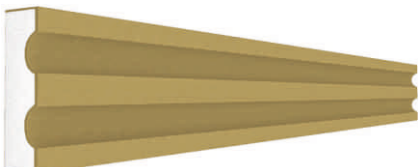

CSV 15

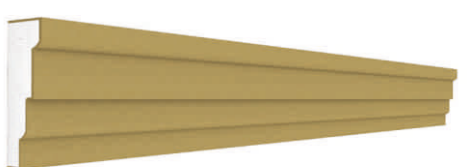
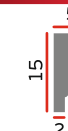

CSV 08

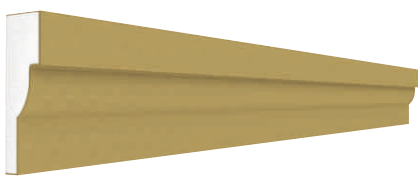

CSV 16

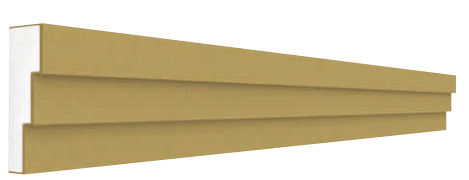

CSV 17



CSV 25

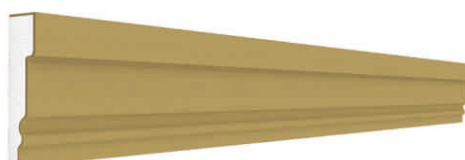

CSV 18



CSV 26

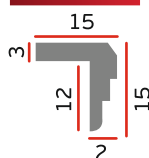

CSV 19

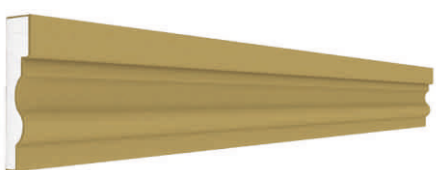
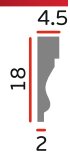

CSV 27

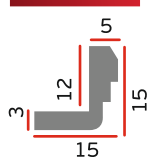

CSV 20

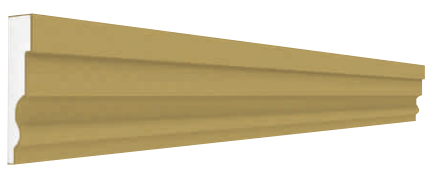

CSV 28

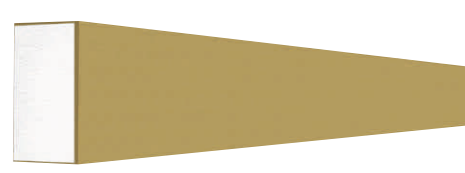
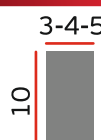

CSV 21



CSV 29

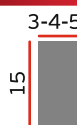

CSV 22

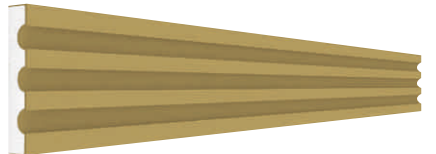

CSV 30

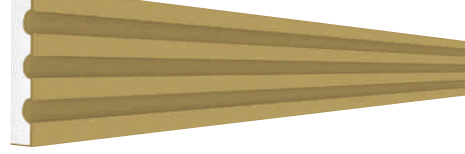
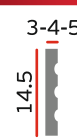

CSV 23

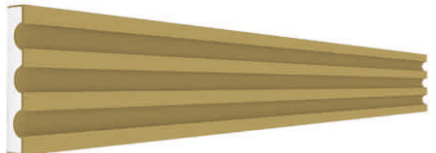

CSV 31



CSV 24

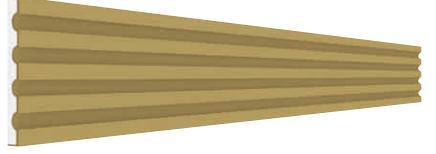

CSV 33

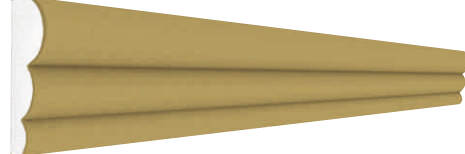

CSV 34

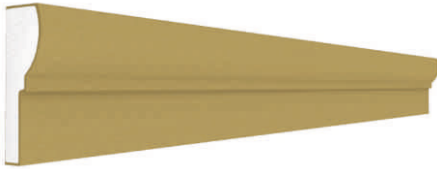

CSV 46

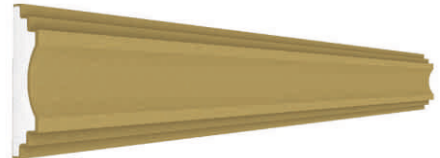
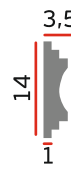

CSV 35

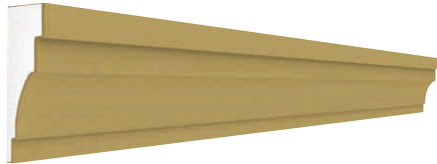

CSV 50

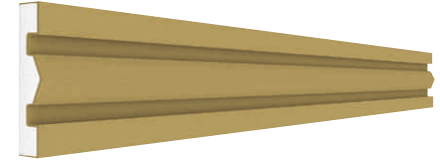

CSV 38

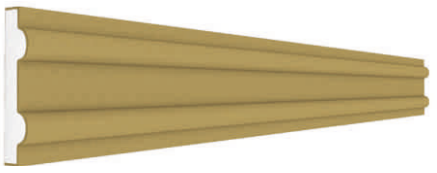

CSV 61

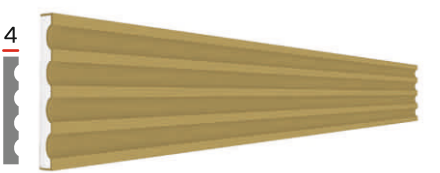
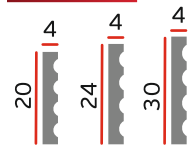

CSV 39

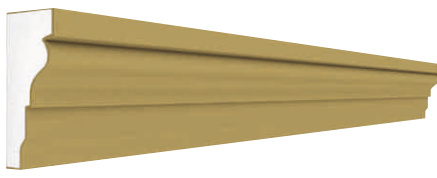
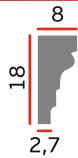

CSV 52



CSV 40

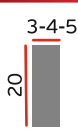

CSV 55

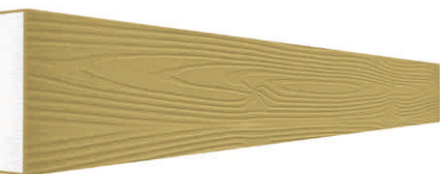

CSV 41

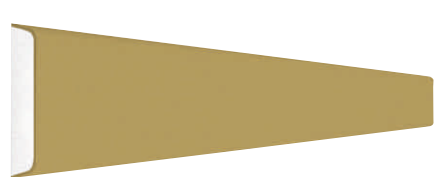
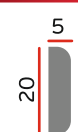

CSV 56

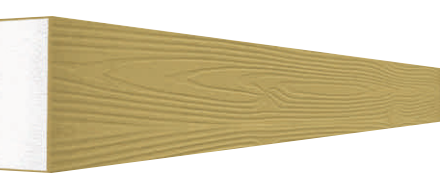

CSV 42

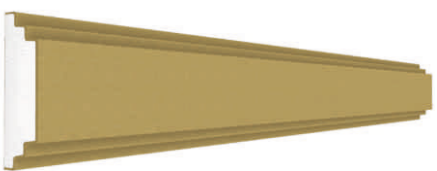

CSV 67



CSV 44

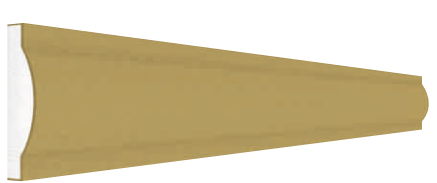

CSV 68

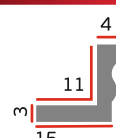

CSV 59

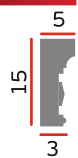

CSV 57

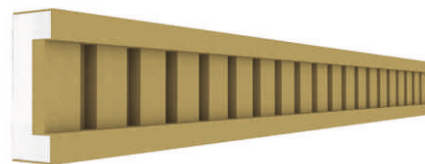

CSV 60

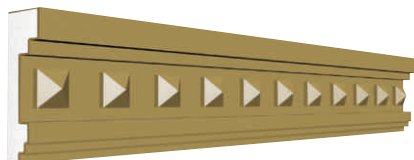

CSV 58

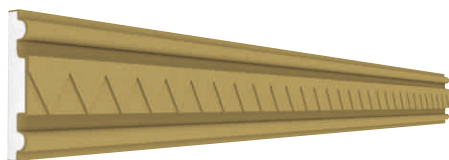

CSV 51

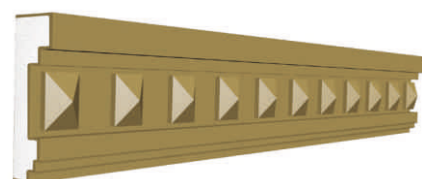

CSV 69 LAMBRISERING

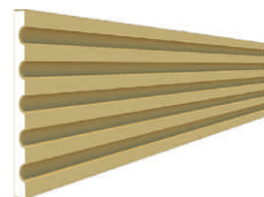
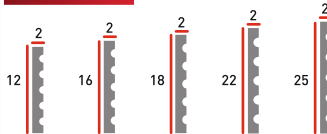

Met deze kan je samen met ÇPY28 een boogconstructie maken

CSV 73



CSV 70

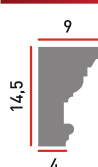

CSV 63

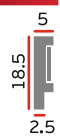

CSV 71

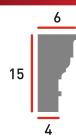

CSV 64



CSV 65



CSV 66

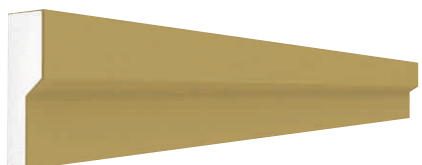

CSV 72



CSV 78

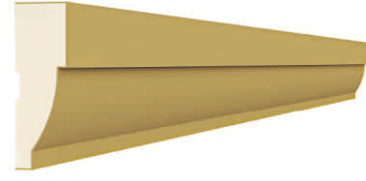

CSV 62

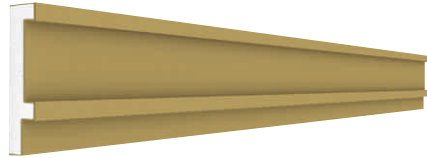
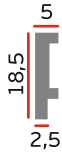

CSV 79

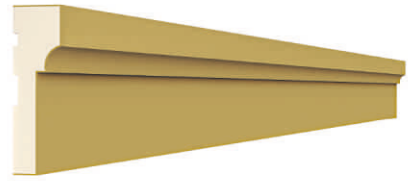

CSV 74

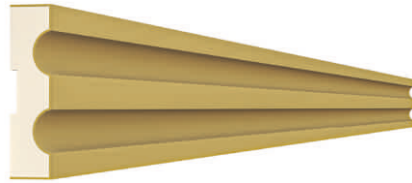

CSV 80

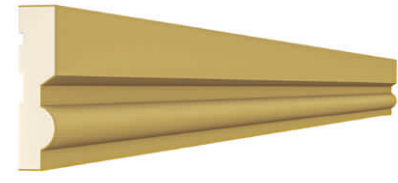

CSV 75

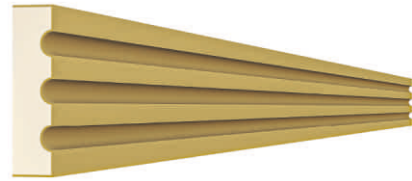

CSV 81



CSV 76

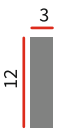

CSV 82



CSV 77

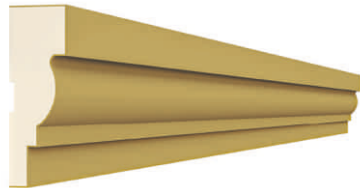
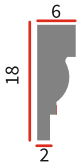

CSV 83

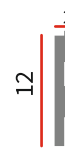

CTAÇ 01

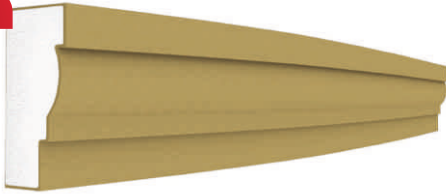
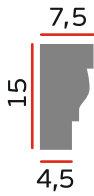

CTAÇ 07

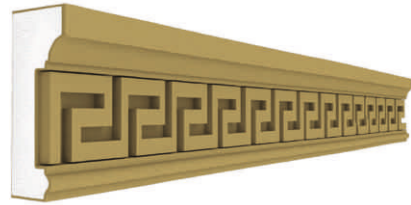

CTAÇ 02

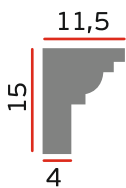

CTAÇ 08

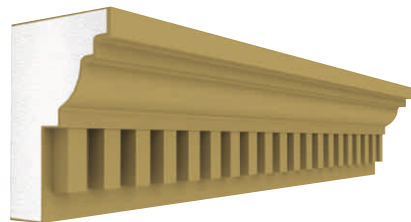
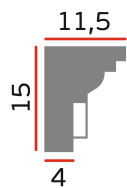

CTAÇ 03

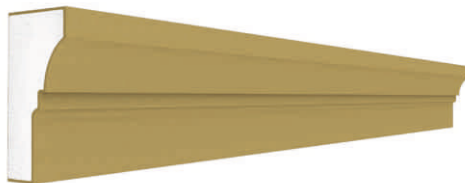
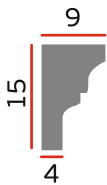

CTAÇ 09

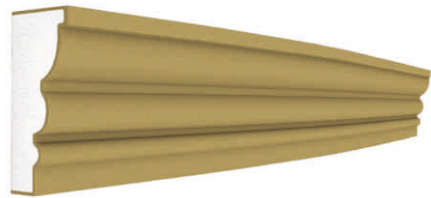
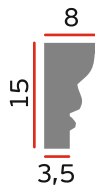

CTAÇ 04

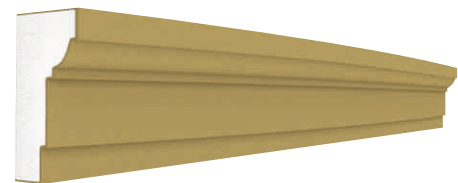

CTAÇ 10

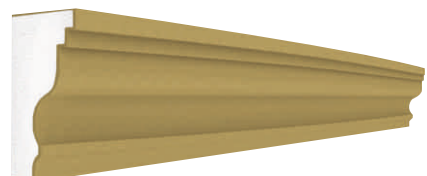

CTAÇ 05

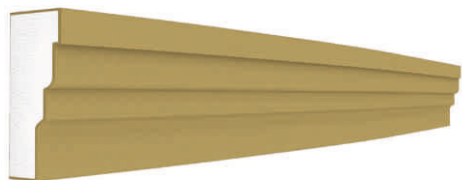

CTAÇ 11

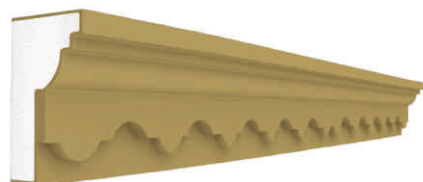
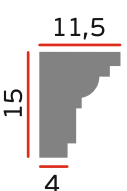

CTAÇ 06

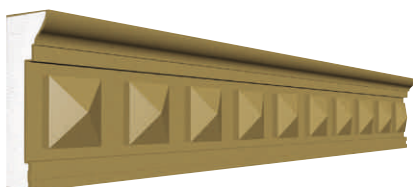
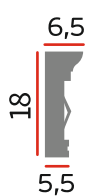

CTAÇ 12

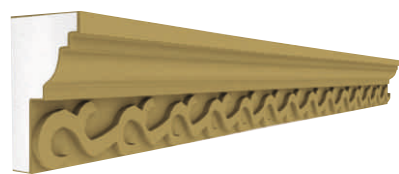
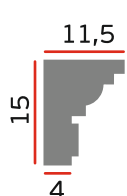

CTAÇ 13



CTAÇ 19

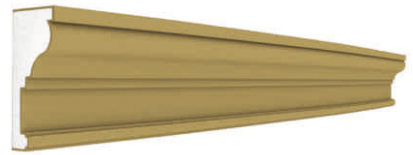

CTAÇ 14

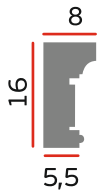

CTAÇ 20

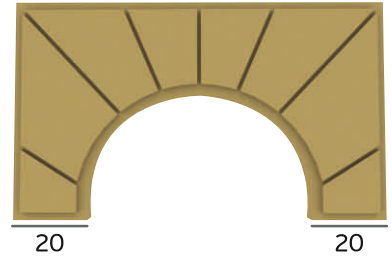
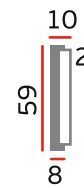

CTAÇ 15

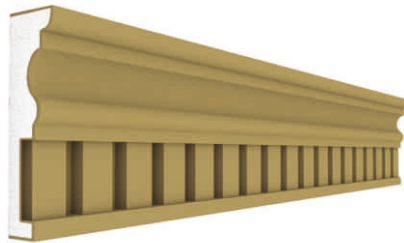

CTAÇ 21

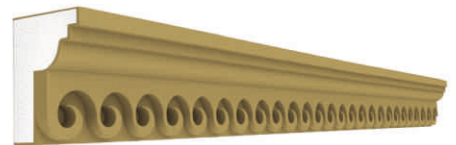
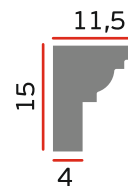

CTAÇ 16

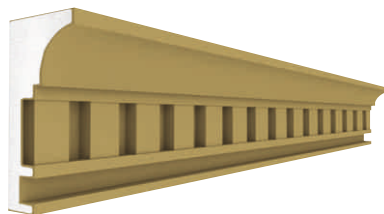

CTAÇ 22

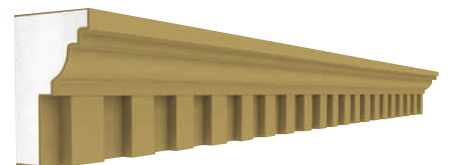
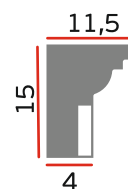

CTAÇ 17

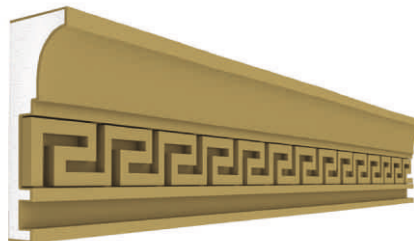

CTAÇ 23

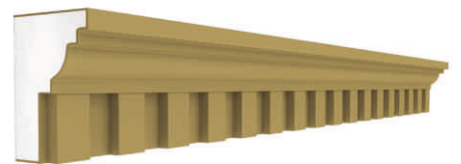

CTAÇ 18

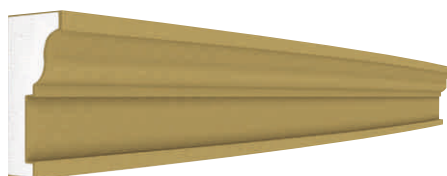



CTD 01



● 80x25x5 ● 100x30x5 ● 120x35x5

CTD 07



● 80x25x5 ● 100x30x5 ● 120x35x5

CTD 02

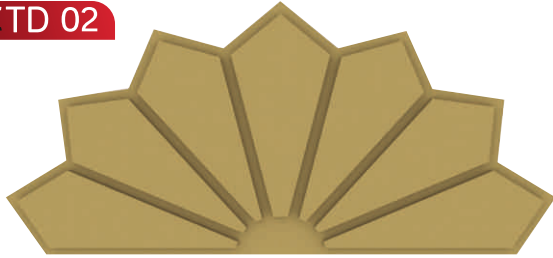

● 80x52x5 ● 100x53x5 ● 120x63x5

CTD 08



● 80x25x5 ● 100x30x5 ● 120x35x5

CTD 03



● 80x25x5 ● 100x30x5 ● 120x35x5

CTD 09



● 80x25x5 ● 100x30x5 ● 120x35x5

CTD 04



● 80x25x5 ● 100x30x5 ● 120x35x5

CTD 12

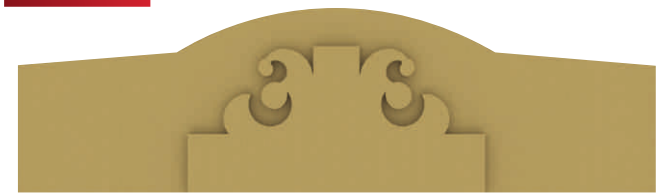

● 80x25x5 ● 100x30x5 ● 120x35x5

CTD 05



● 80x25x5 ● 100x30x5 ● 120x35x5

CTD 13



● 80x25x5 ● 100x30x5 ● 120x35x5

CTD 06



● 80x25x5 ● 100x30x5 ● 120x35x5

CTD 14

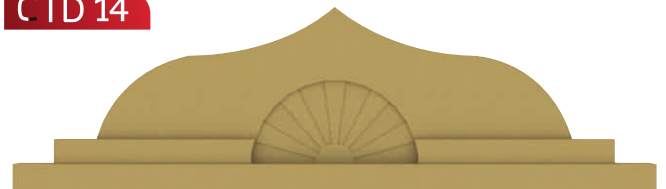

● 80x25x5 ● 100x30x5 ● 120x35x5

CTD 15



● 80x16x5 ● 100x20x5 ● 120x24x5

CTD 20



● 100x37x5 ● 120x37x5 ● 150x37x5 ● 200x37x5

CTD 16



● 80x22x5 ● 100x27x5 ● 120x32x5

CTD 21



● 100x35x5 ● 120x42x5

CTD 17



● 80x24x5 ● 100x30x5 ● 120x36x5

CTD 22



● 150x50x7 ● 200x50x7

CTD 18



● 80x24x5 ● 100x30x5 ● 120x36x5

CTD 23



● 150x50x8 ● 120x40x8 ● 310x80x10

CTD 19



● 80x37x5 ● 100x46x5 ● 120x55x5



Vensterbank en Kroonafdekking
Sail and Crown Cover / العتبات وغطاء التاج

Ieder model wordt apart gefabriceerd. Bij bestelling geef je als bij de voorbeeld hieronder de ÇKapak product code door.

Voorbeeld: ÇKapak - ÇTaç 08

Kan voor alle Vensterbank en Kroonafdekking worden geproduceerd.

It can be produced according to all Sail and crown models.

تستطيع أن تنتج حسب كل موديلات العتبات و التاج

CDN 02

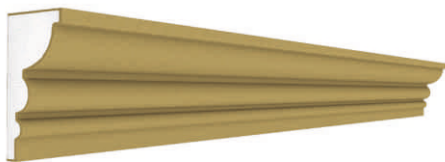

CDN 08

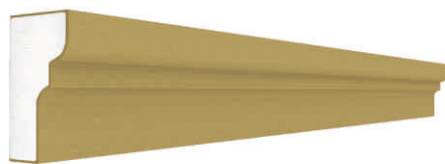

CDN 03

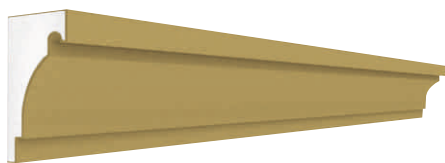
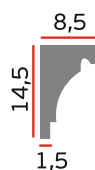

CDN 09

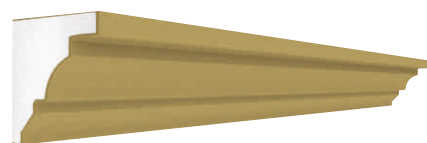
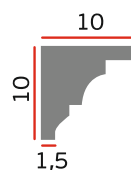

CDN 04

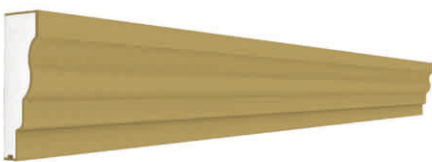
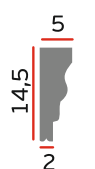

CDN 10

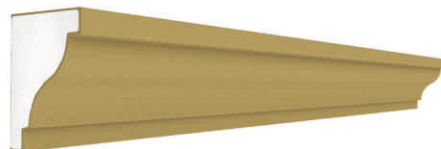

CDN 05



CDN 11

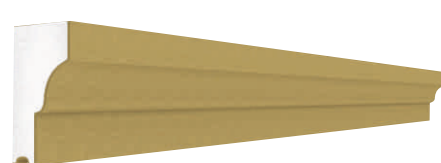

CDN 06

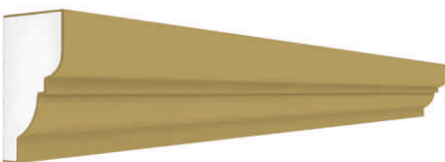

CDN 12

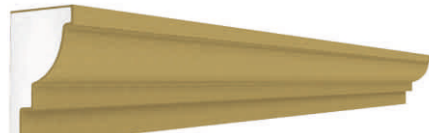

CDN 07

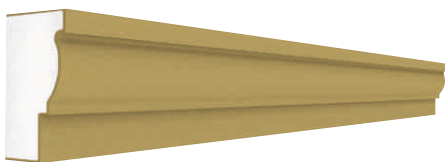

CDN 13

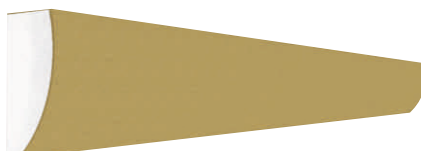

CDN 14

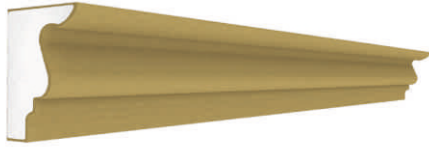

CDN 21

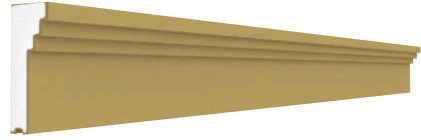
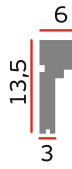

CDN 15

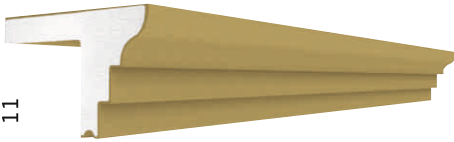
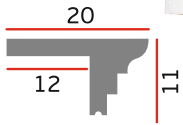

CDN 22

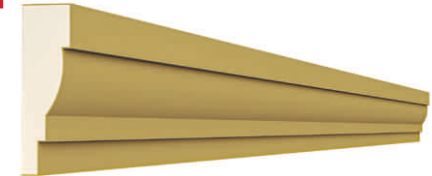

CDN 16

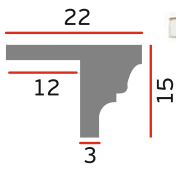

CDN 23

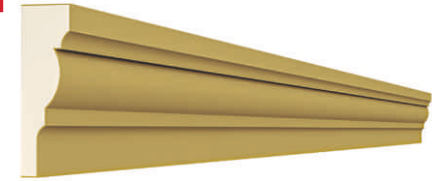

CDN 17

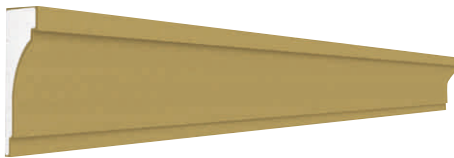
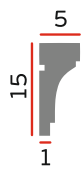

CDN 24



CDN 18

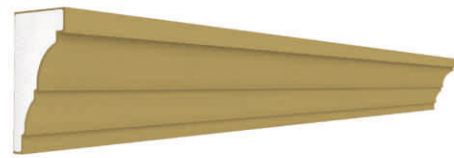
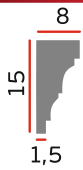

CDN 25

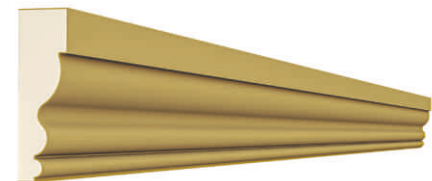

CDN 19

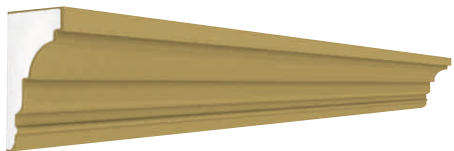
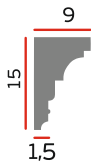

CDN 26

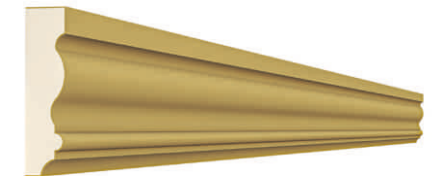

CDN 20

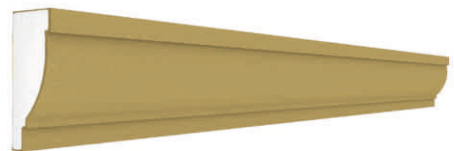

CDN 27

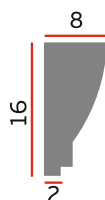

CKS 01

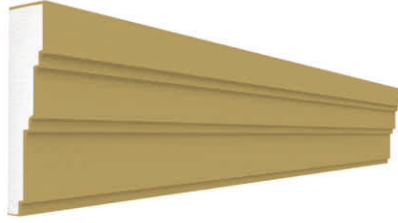

CKS 09

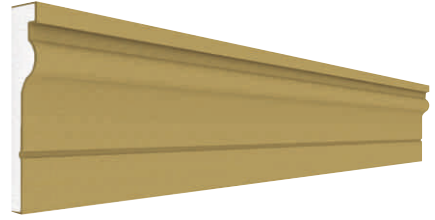

CKS 02



CKS 10

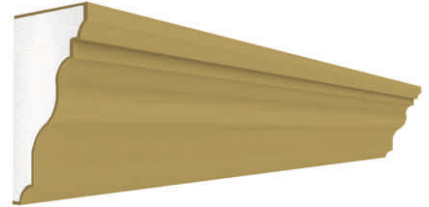
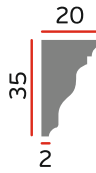

CKS 04

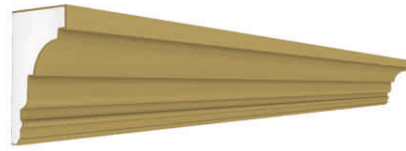

CKS 11

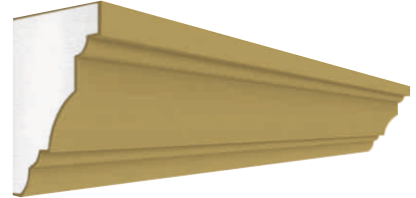

CKS 05

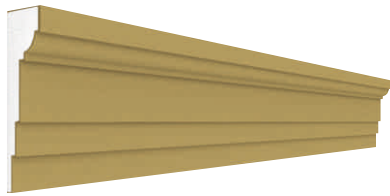

CKS 38

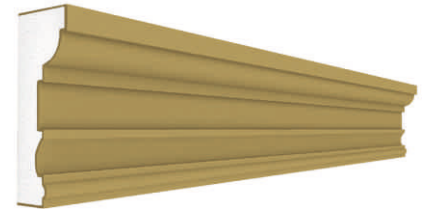
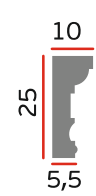

CKS 06



CKS 39

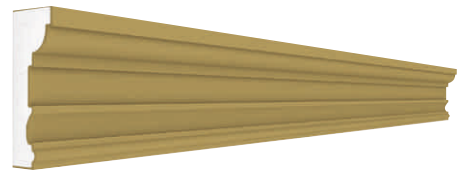

CKS 07

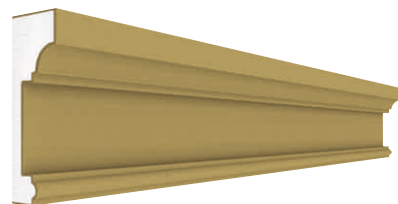

CKS 40



CKS 08

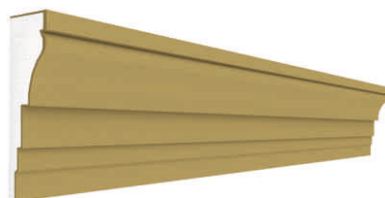

CKS 51

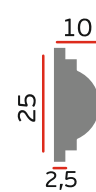

CKS 50

8
32
3

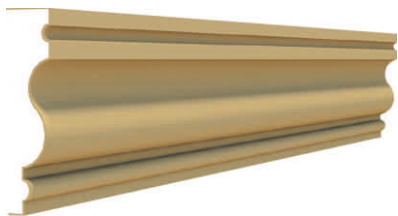

CKS 58

15
30
6

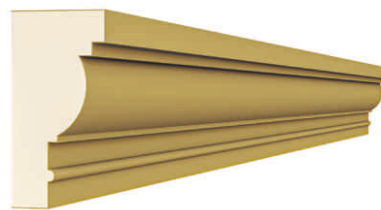

CKS 52

20
38
4

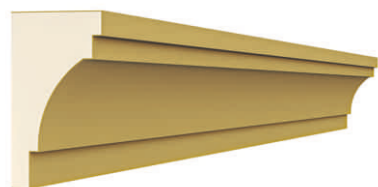

CKS 59

28
40
3

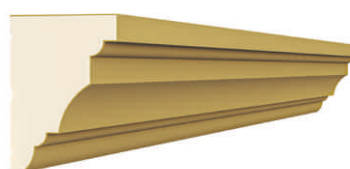

CKS 53

7
30
4



CKS 62

9
20
4

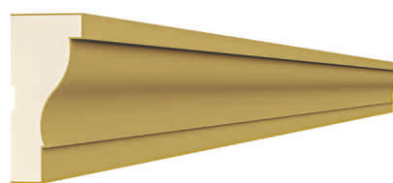

CKS 54

6,5
30



CKS 63

13
30
6

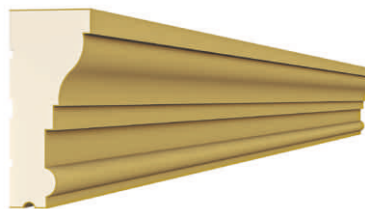

CKS 55

9
30

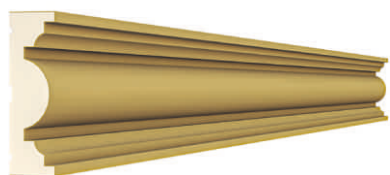

CKS 64

15
30
2

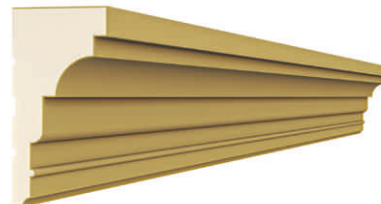

CKS 56

15
20
4

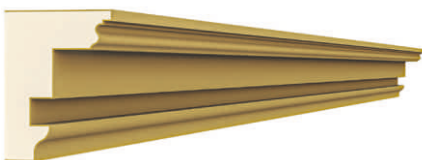

CKS 65

11
30
4

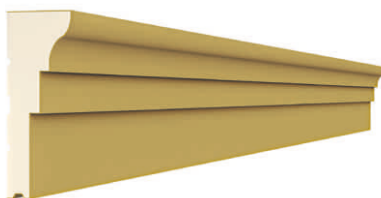

CKS 57

10
25
2,5

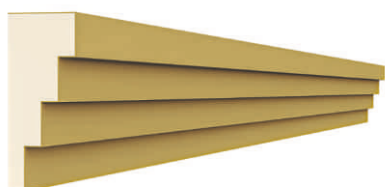

CKS 66

15
25
5

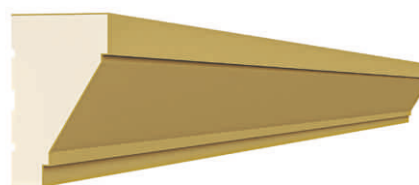

CKS 23

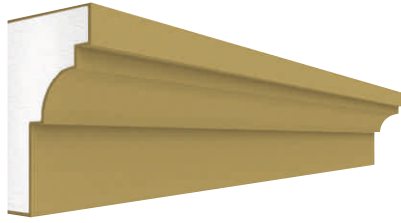

CKS 30

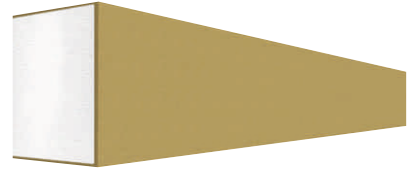
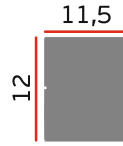

CKS 24

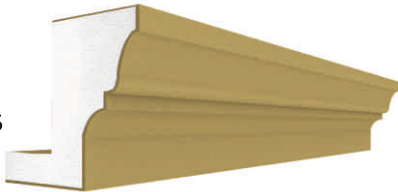
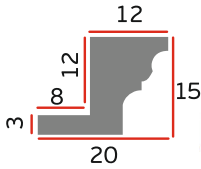

CKS 48



CKS 27

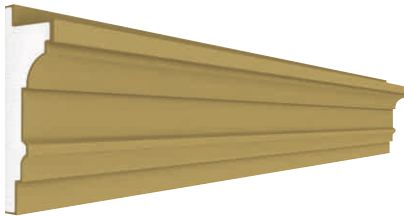

CKS 49

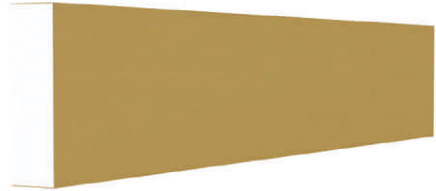
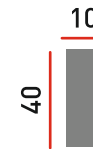

CKS 60

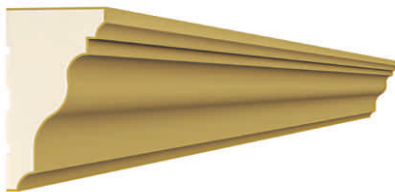
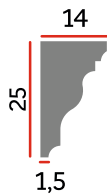

CKS 28

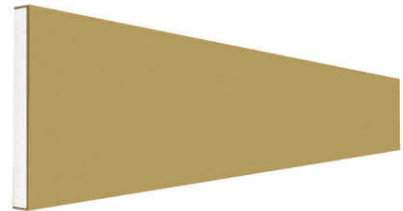
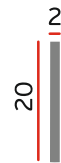

Empire

DECORATIONS

Add value
to your home



CKS 33



CKS 41

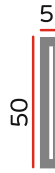

CKS 34

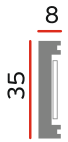

CKS 42



CKS 35

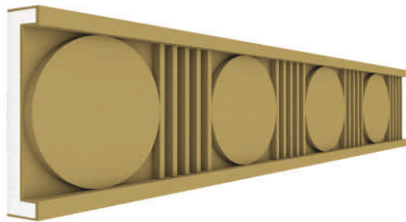

CKS 43

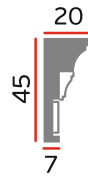

CKS 12

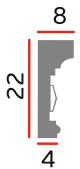

CKS 44



CKS 13

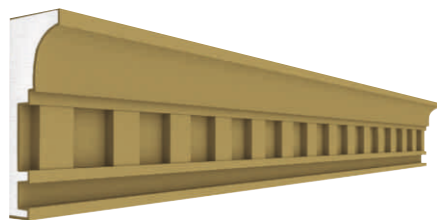
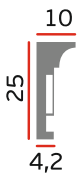

CKS 45

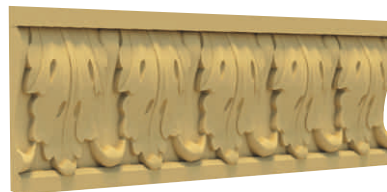
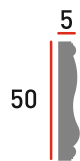

CKS 14

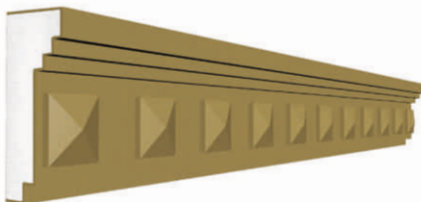

CKS 46

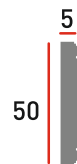

CKS 15



CKS 47



CKS 31



CKS 16

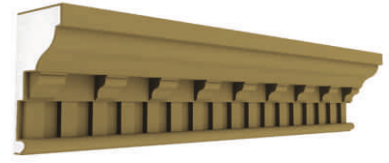
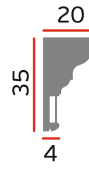

CKS 32

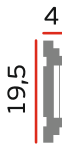

CKS 17

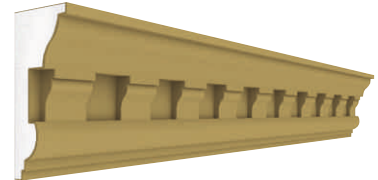

CKS 37

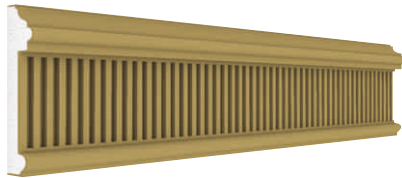

CKS 18

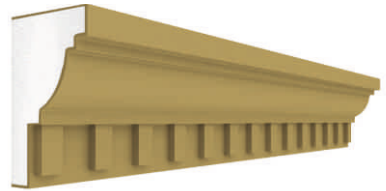

CKS 61

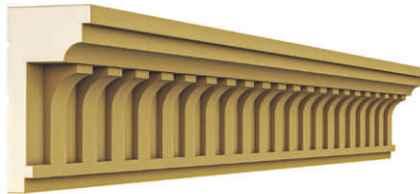

CKS 19

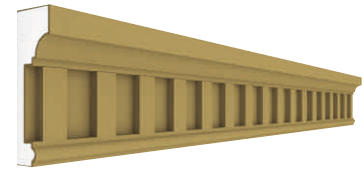
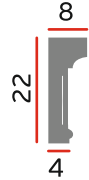

CKS 20

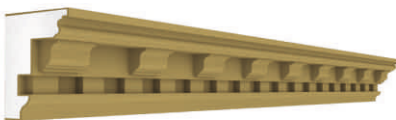

CKS 21

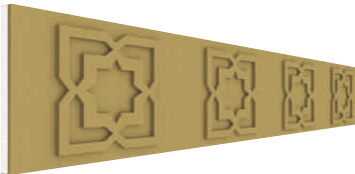
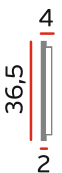

CKS 22

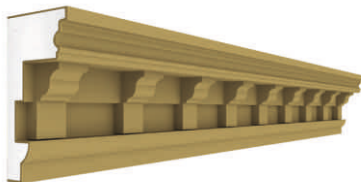
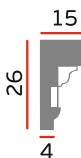

CHP 01

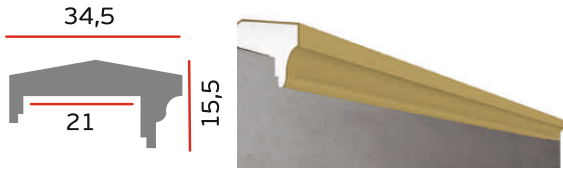

CHP 03

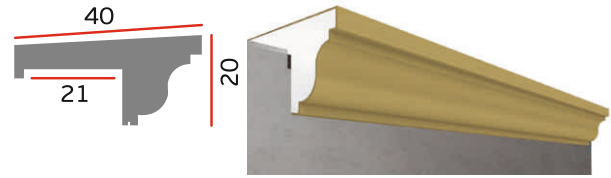

CHP 02

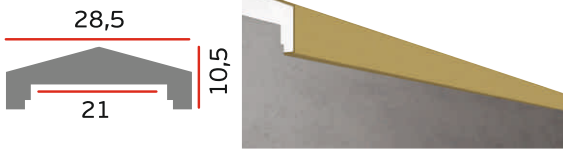

CHP 04



Round Window Frame

CYP 01



CYP 03



CYP 02



CYP 04

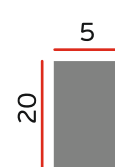

Balustrade

CBLS 01

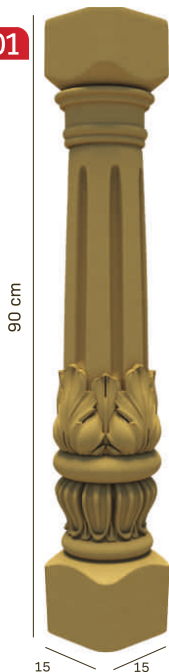

CBLS 02



CBLS 03

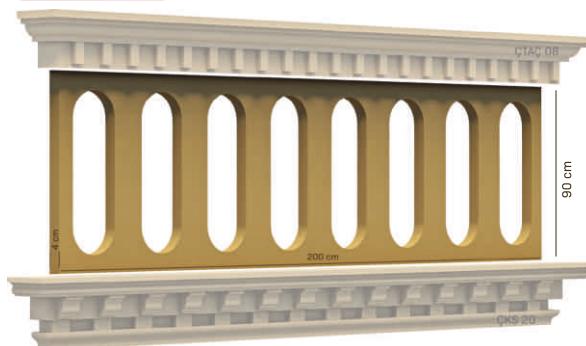

Please note that the ÇBLS03 product shown above is mounted between the following products ÇTAÇ08 and ÇKS20. The other products are shown for illustration purposes.

DECORATIONS

CCT 01

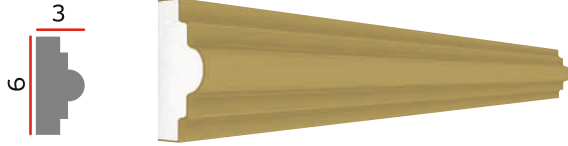

CCT 11



CCT 02



CCT 12



CCT 03

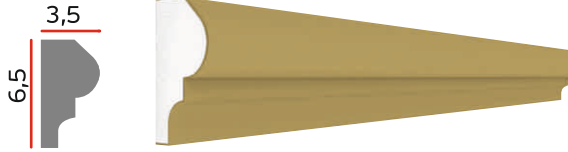

CCT 13



CCT 04



CCT 14



CCT 05



CCT 15



CCT 06

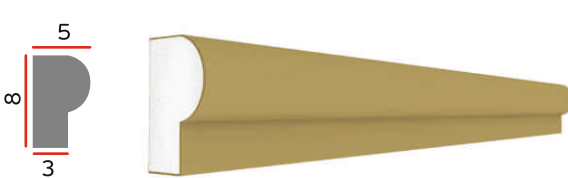

CCT 16

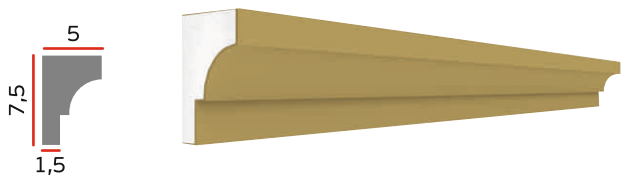

CCT 07

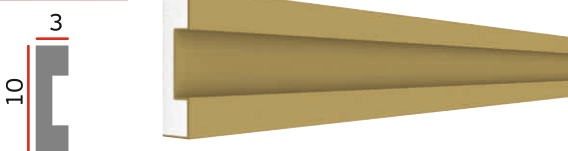

CCT 17



CCT 08



CCT 18



CCT 10



CCT 19



Manufactured with XPS

DECORATIONS

CÇT 20



Manufactured with XPS

CÇT 22

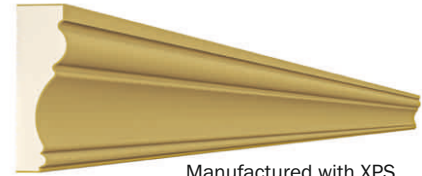
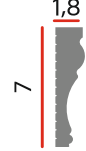

Manufactured with XPS

CÇT 21



Manufactured with XPS

CÇT 23



Manufactured with XPS

CÇT 24

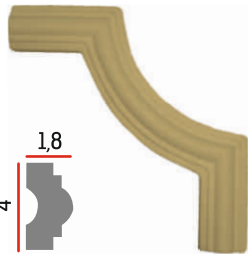

CÇT 25

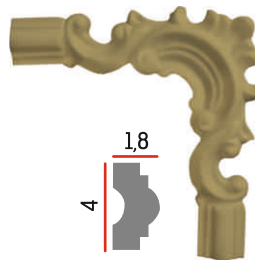

CÇT 26



CLED 01

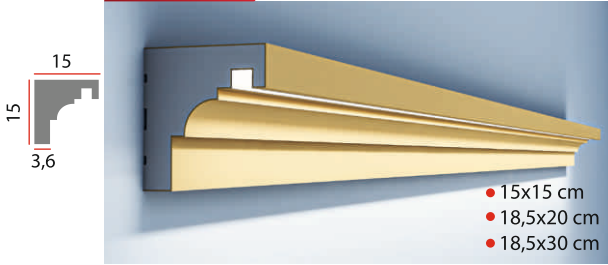

CLED 06

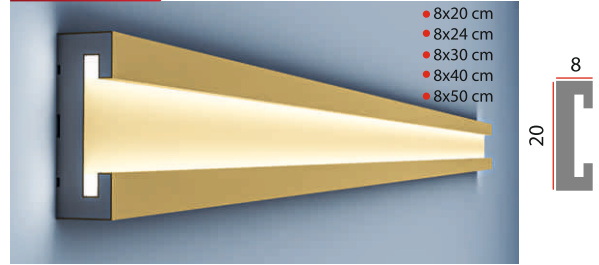

CLED 02

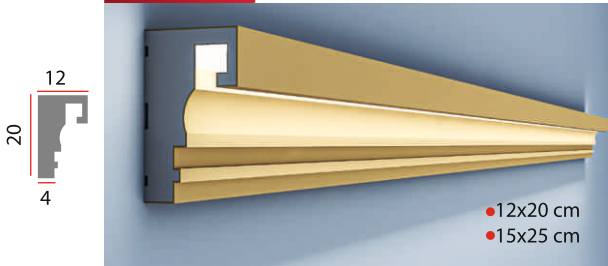

CLED 07

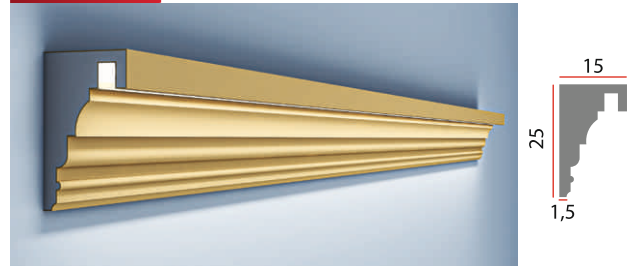

CLED 03

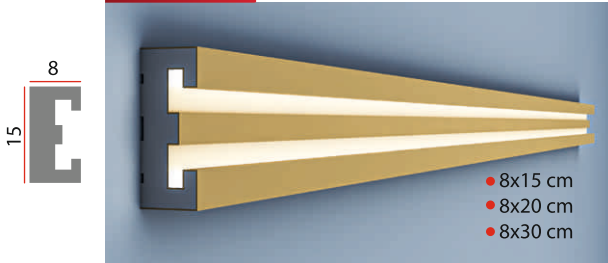

CLED 08

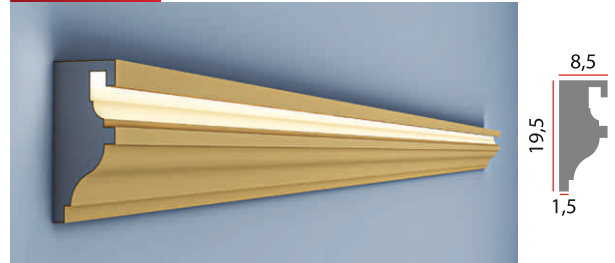

CLED 04

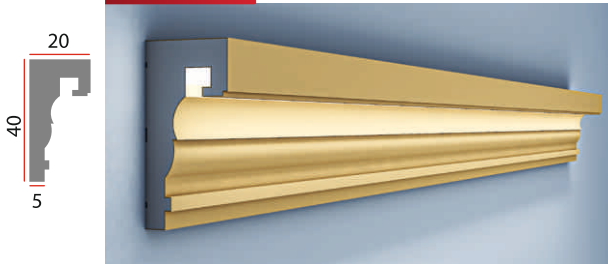

CLED 09

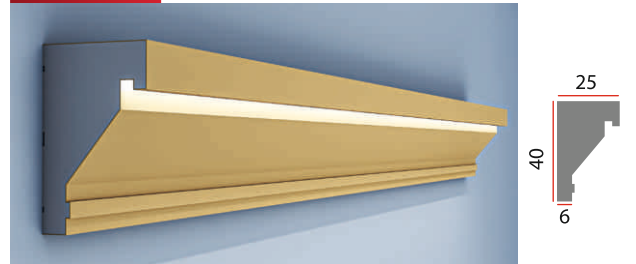

CLED 05



CLED 10

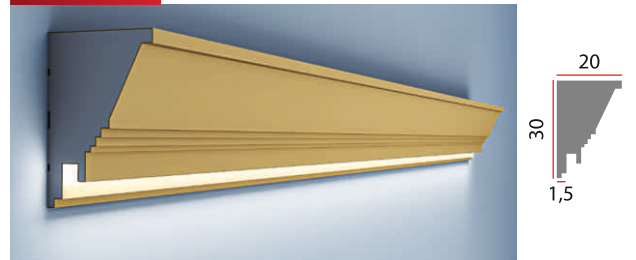

CLED 11

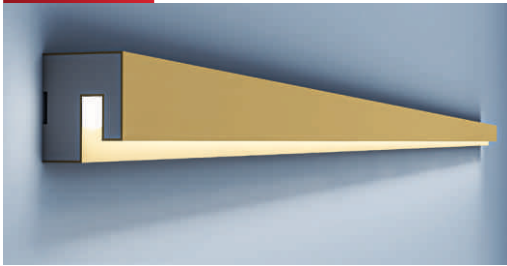

CLED 13

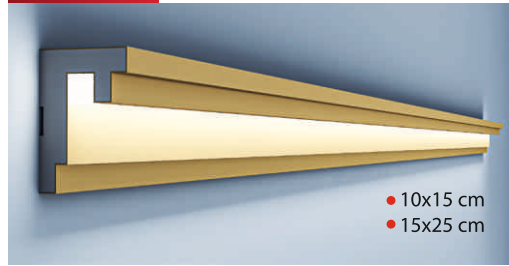

CLED 12

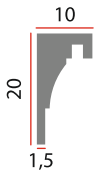

CLED 14

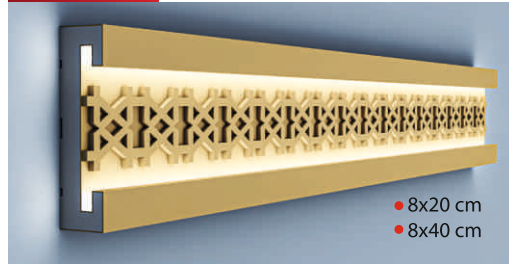
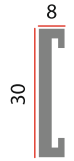

DECORATIONS

CKE 01

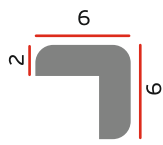

CKE 16

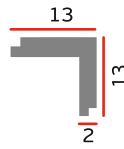

CKE 02

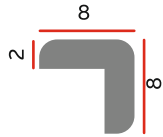

CKE 17

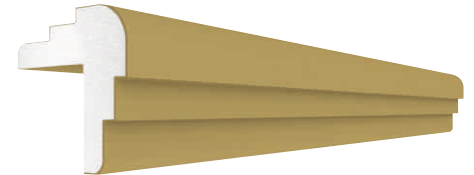
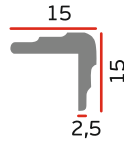

CKE 03

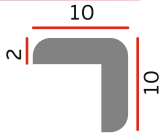

CKE 19

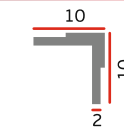

CKE 04

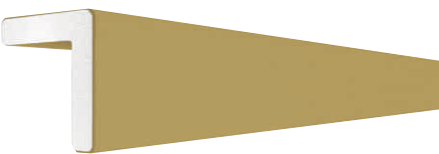
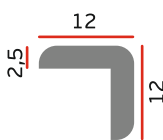

CKE 26

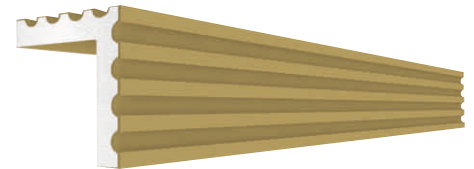
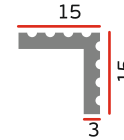

CKE 05

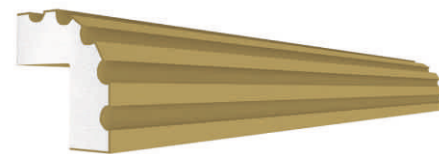
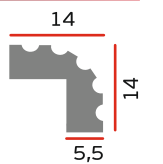

CKE 27

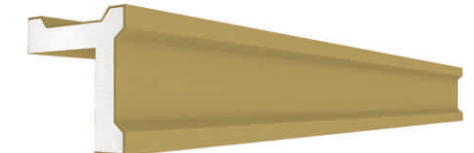

CKE 11

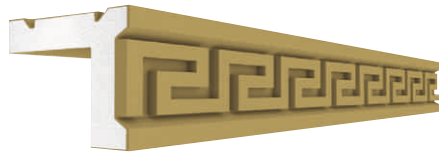
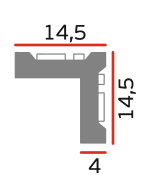

CKE 28

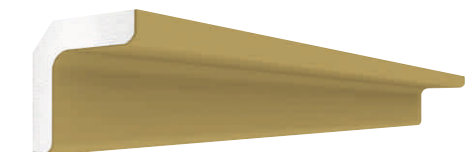

CKE 12

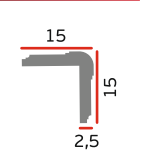

CKE 29

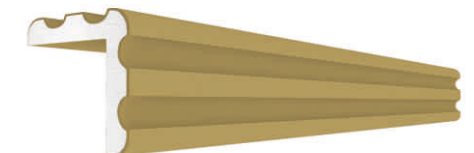
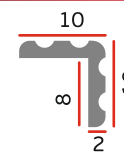

CKE 15

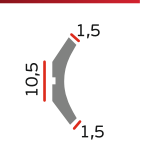

CKE 38

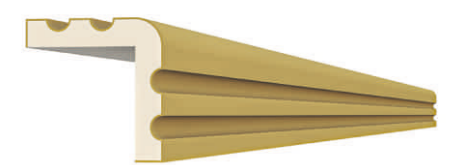
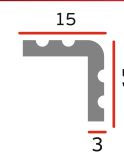

CKE 13

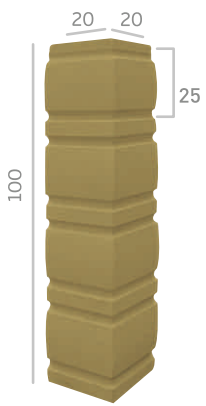

CKE 14

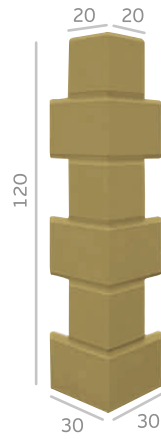

CKE 18

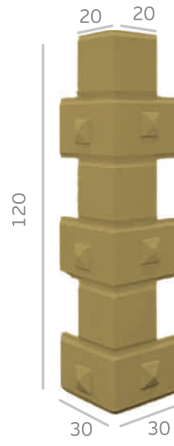

CKE 20

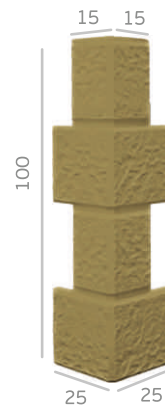

CKE 21

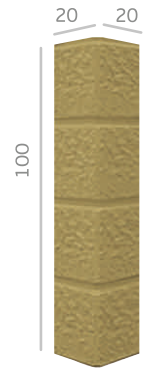

CKE 22

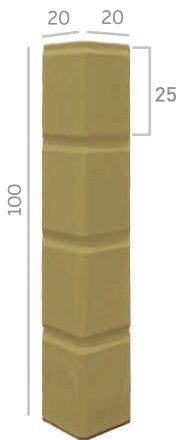

CKE 24

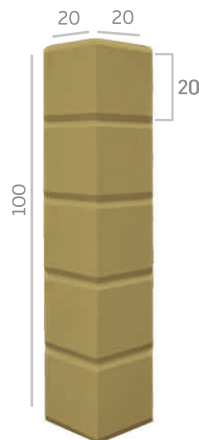

CKE 30

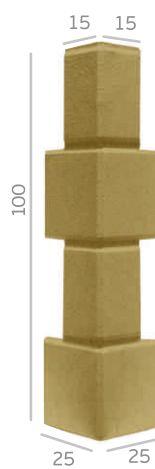

CKE 31

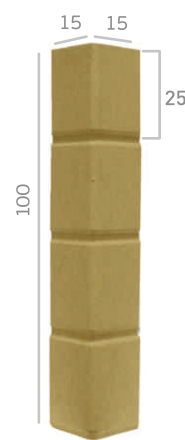

CKE 32



CKE 33



CKE 34



CKE 35

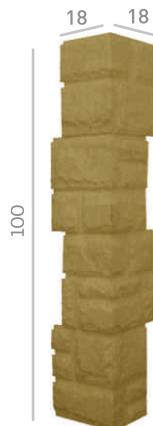

CKE 36



CKE 37

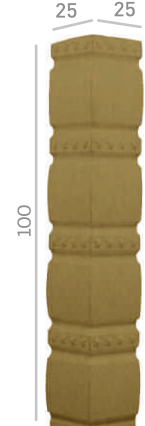



CBK 01

10x10
12x12
18x18 2,5

- Ø 10
- Ø 12
- Ø 18



CBK 02

10x10
12x12
18x18 2,5

- Ø 10
- Ø 12
- Ø 18



CBK 03

10x10
12x12
18x18 2,5

- Ø 10
- Ø 12
- Ø 18



CBK 04

10x10
12x12
18x18 2,5

- Ø 10
- Ø 12
- Ø 18



CBK 05

10x10
12x12
18x18 2,5

- Ø 10
- Ø 12
- Ø 18



CBK 06

10x10
12x12
18x18 2,5

- Ø 10
- Ø 12
- Ø 18



CBK 07

13x25 2,5

2,5

CKLN 01

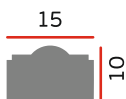

CKLN 04



CKLN 09

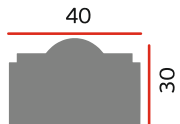

CKLN 02

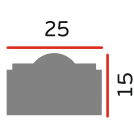

CKLN 05

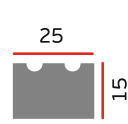

CKLN 07

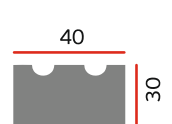

CKLN 10

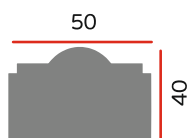

CKLN 03

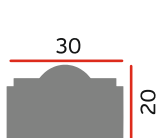

CKLN 06

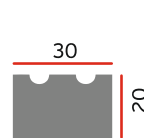

CKLN 08

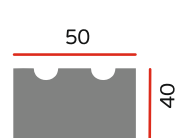

The only difference is the era
La única diferencia es la época
Het enige verschil is het tijdperk



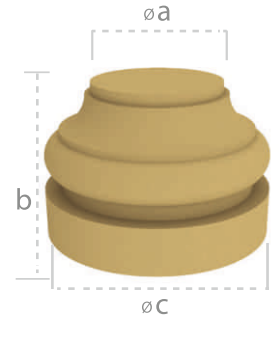
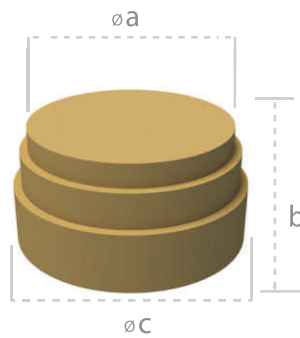
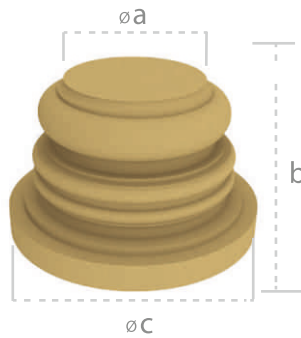
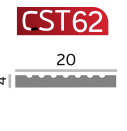
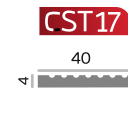
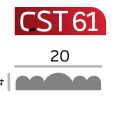
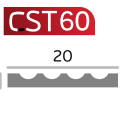
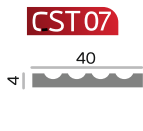
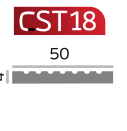
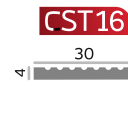
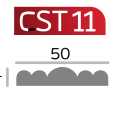
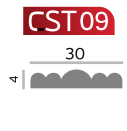
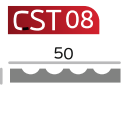
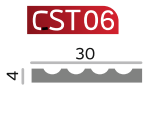
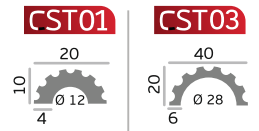
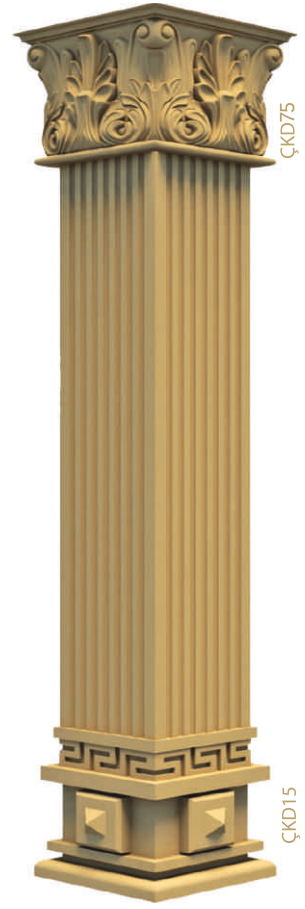
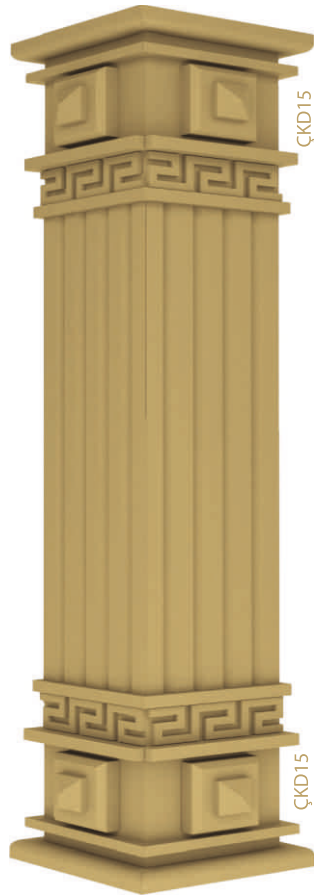
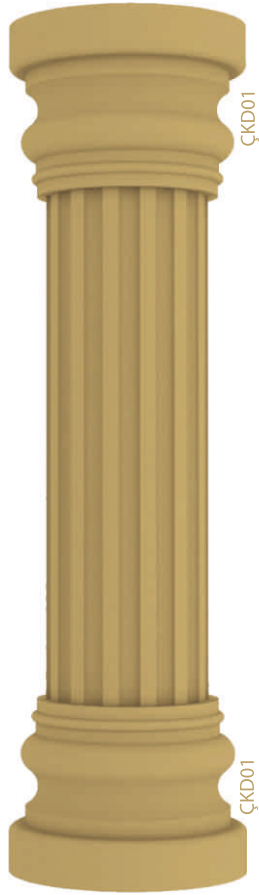

CKD 01	øa:22 b:25 øc:30	CKD 03	øa:42 b:25 øc:50
CKD 02	øa:32 b:25 øc:40	CKD 88	øa:52 b:25 øc:60

CKD 06	øa:22 b:25 øc:30	CKD 22	øa:42 b:25 øc:50
CKD 21	øa:32 b:25 øc:40		

CKD 07	øa:22 b:25 øc:30	CKD 24	øa:42 b:25 øc:50
CKD 23	øa:32 b:25 øc:40		

CKD 08	øa:22 b:25 øc:30	CKD 26	øa:42 b:25 øc:50
CKD 25	øa:32 b:25 øc:40	CKD 90	øa:52 b:25 øc:60

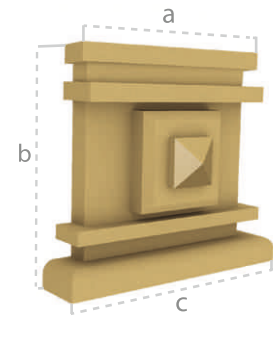
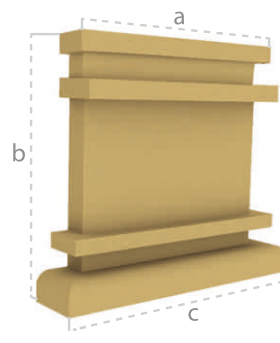
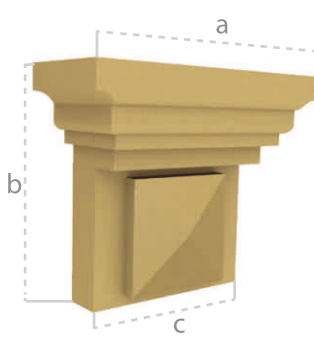
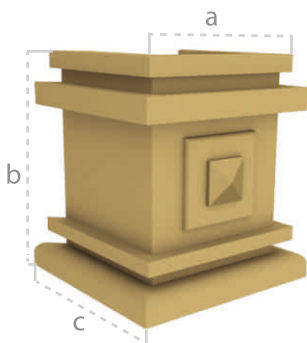
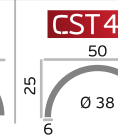
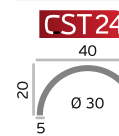
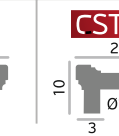
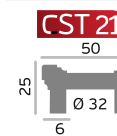
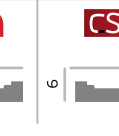
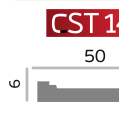
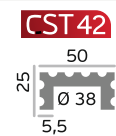
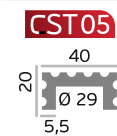
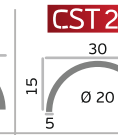
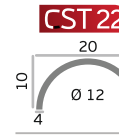
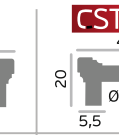
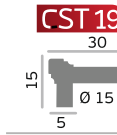
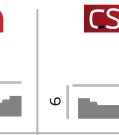
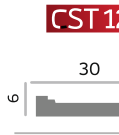
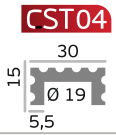
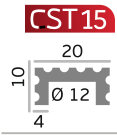
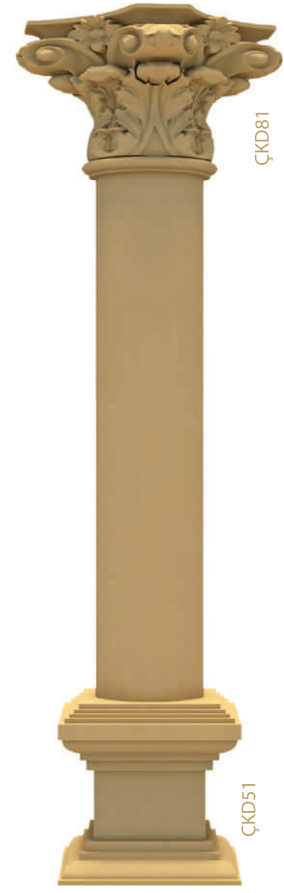
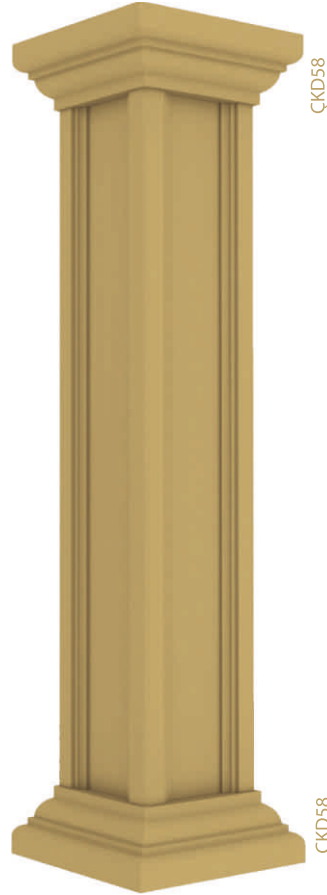
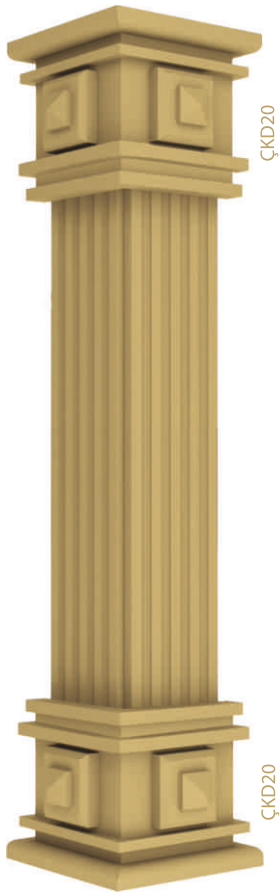

CKD 20	a:22 b:40 c:11	CKD 04	a:32 b:40 c:16
CKD 05	a:42 b:40 c:21	CKD 89	a:52 b:40 c:26

CKD 18	a:48 b:25 c:33	CKD 30	a:68 b:25 c:53
CKD 29	a:58 b:25 c:43	CKD137	a:38 b:25 c:23

CKD 12	a:33 b:40 c:40	CKD 14	a:53 b:40 c:60
CKD 13	a:43 b:40 c:50	CKD134	a:23 b:40 c:30

CKD 09	a:33 b:40 c:40	CKD 11	a:53 b:40 c:60
CKD 10	a:43 b:40 c:50	CKD138	a:23 b:30 c:40

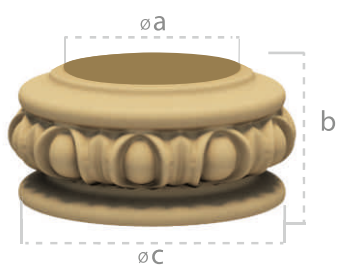
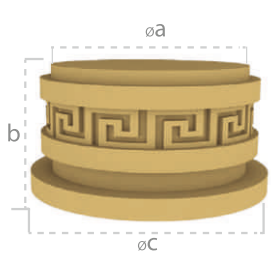
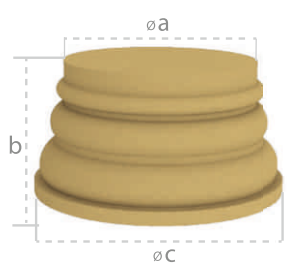
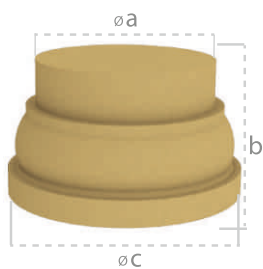
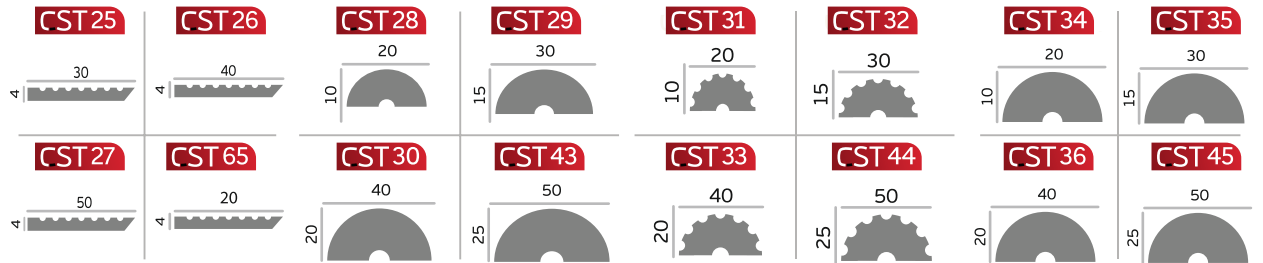
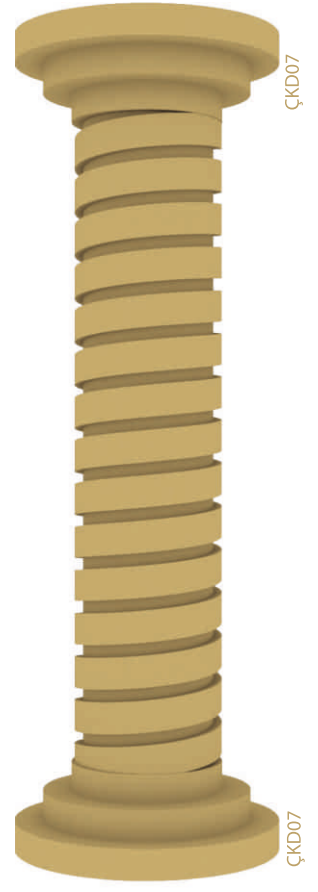
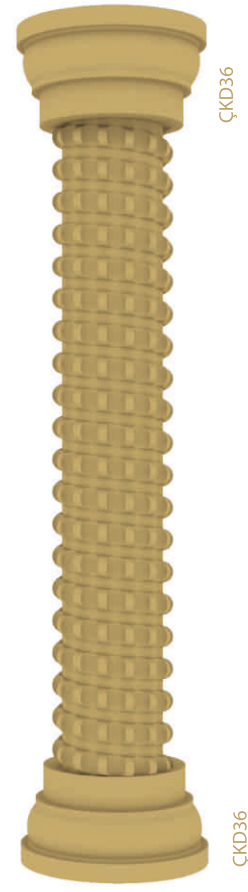
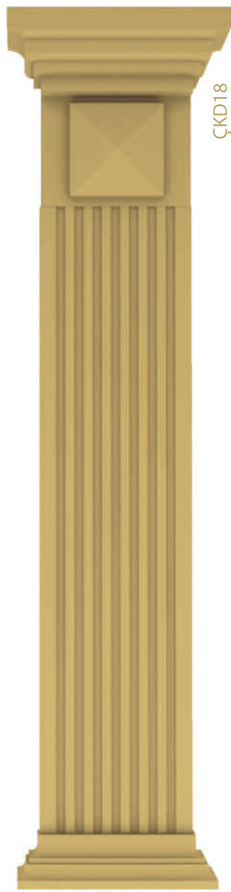

CKD 36	øa:22 b:15 øc:30	CKD 38	øa:42 b:15 øc:50
CKD 37	øa:32 b:15 øc:40	CKD 92	øa:52 b:15 øc:60

CKD 33	øa:22 b:15 øc:30	CKD 35	øa:42 b:15 øc:50
CKD 34	øa:32 b:15 øc:40	CKD 91	øa:52 b:15 øc:60

CKD 69	øa:22 b:32 øc:42	CKD 71	øa:52 b:32 øc:60
CKD 70	øa:42 b:32 øc:50	CKD 114	øa:32 b:32 øc:40

CKD 115	øa:22 b:15 øc:30	CKD 117	øa:42 b:22 øc:50
CKD 116	øa:32 b:15 øc:40	CKD 140	øa: 52 b: 38,5 øc: 78

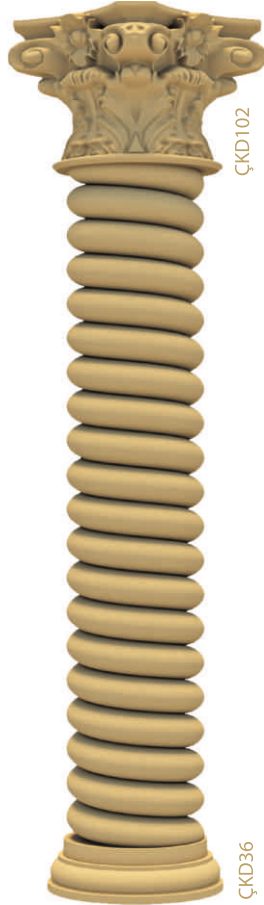

CST 37

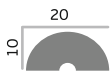

CST 38

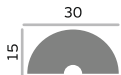

CST 28



CST 29



CST 22

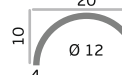

CST 23

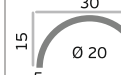

CST 39



CST 46



CST 30



CST 43



CST 24

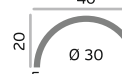

CST 41

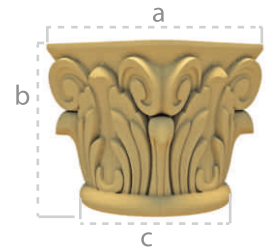
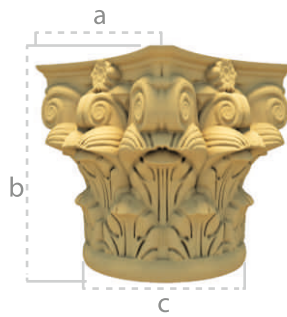
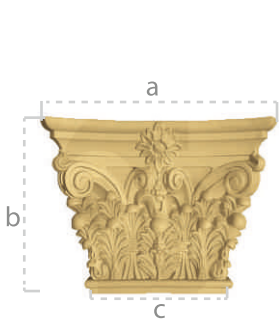
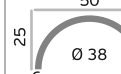

CKD 75	a:37 b:40 c:22	CKD 77	a:70 b:50 c:42
CKD 76	a:53 b:50 c:32	CKD 78	a:87 b:50 c:52

CKD 81	a:32 b:40 c:22	CKD 83	a:60 b:50 c:42
CKD 82	a:46 b:50 c:32	CKD 84	a:95 b:50 c:52

CKD 96	a:51 b:50 c:32	CKD 98	a:84 b:50 c:52
CKD 97	a:69 b:50 c:42		

CKD 99	a:66 b:50 c:32	CKD 101	a:79 b:50 c:52
CKD 100	a:70,3 b:50 c:42		

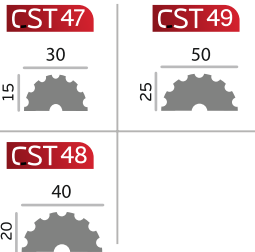

CKD 102	a:52 b:50 c:32	CKD 104	a:82 b:50 c:52
CKD 103	a:65 b:50 c:42		

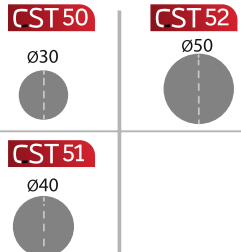

CKD 105	a:50 b:50 c:35	CKD 107	a:75 b:50 c:55
CKD 106	a:62 b:50 c:45	Wordt met een dikte van 16,5 cm geproduceerd	

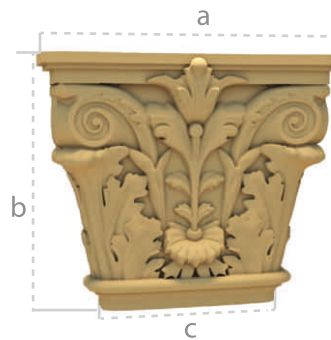
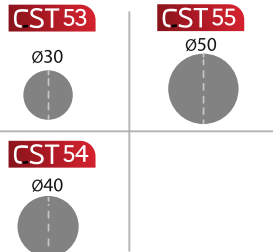

CKD 108	a:56 b:50 c:35	CKD 110	a:90 b:50 c:55
CKD 109	a:72 b:50 c:45	Wordt met een dikte van 15 cm geproduceerd	

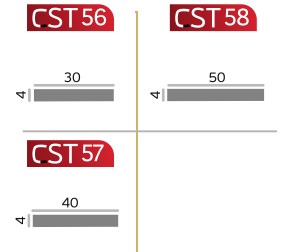
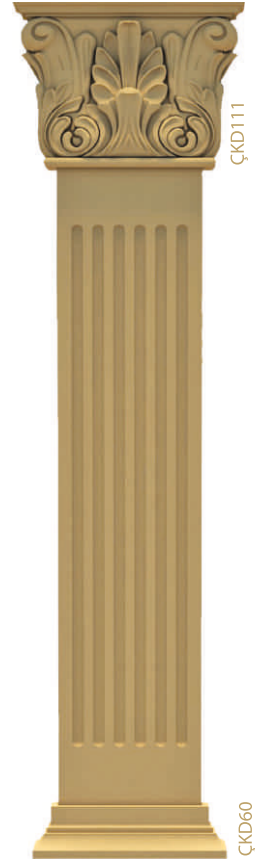

CKD 111	a:50 b:50 c:35	CKD 113	a:77 b:50 c:55
CKD 112	a:62 b:50 c:45	Wordt met een dikte van 12,5 cm geproduceerd	

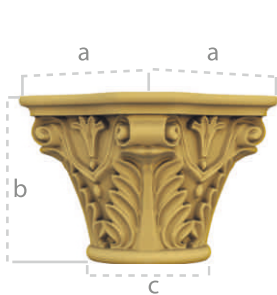
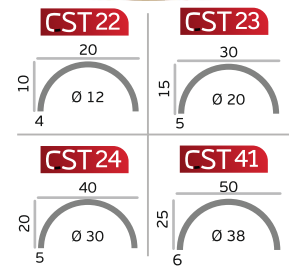
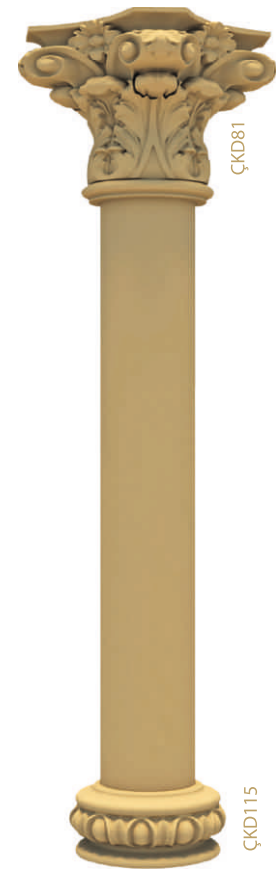
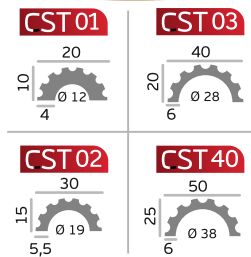
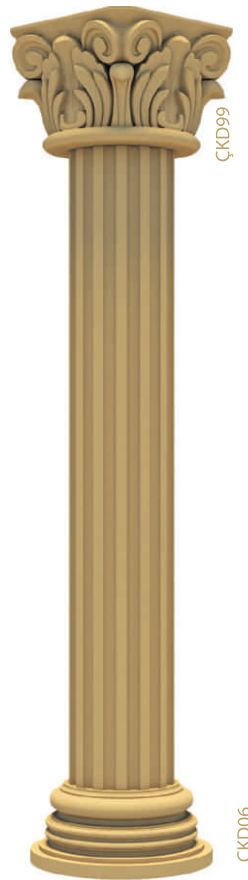
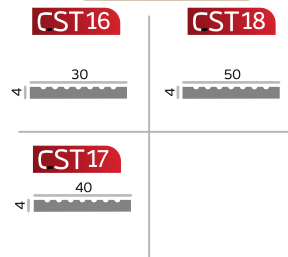
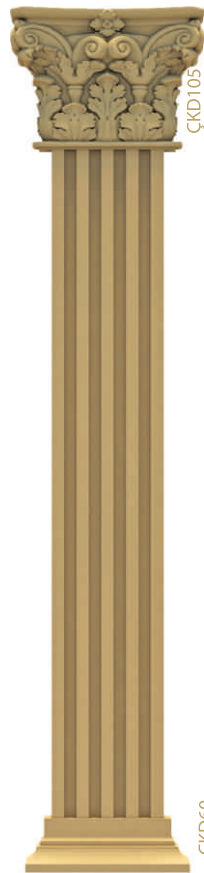
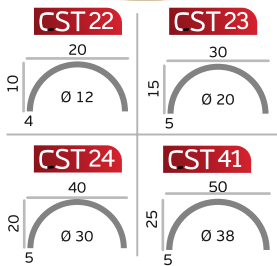

ÇKD 118	a: 42 b: 40 c: 22	ÇKD 120	a: 80 b: 50 c: 42
ÇKD 119	a: 61 b: 50 c: 32	ÇKD 121	a: 99 b: 50 c: 52



ÇKD 122	a: 48 b: 40 c: 22	ÇKD 124	a: 91 b: 50 c: 42
ÇKD 123	a: 70 b: 50 c: 32	ÇKD 125	a: 112 b: 50 c: 52

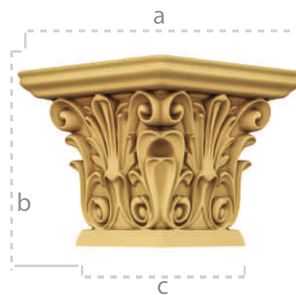

ÇKD 126	a: 49 b: 40 c: 22	ÇKD 128	a: 94 b: 50 c: 42
ÇKD 127	a: 72 b: 50 c: 32	ÇKD 129	a: 116 b: 50 c: 52

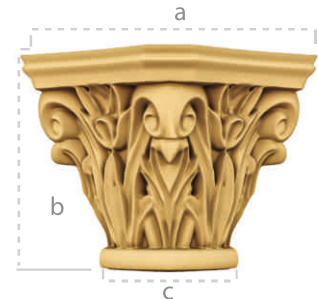

ÇKD 130	a: 47 b: 40 c: 22	ÇKD 132	a: 90 b: 50 c: 42
ÇKD 131	a: 69 b: 50 c: 32	ÇKD 133	a: 111 b: 50 c: 52

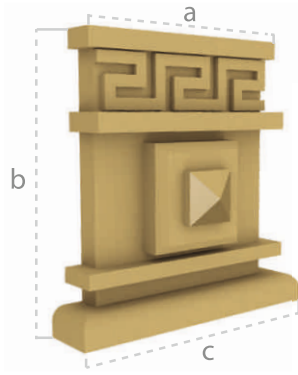

CKD 15	a:33 b:40 c:40	CKD 17	a:53 b:40 c:60
CKD 16	a:43 b:40 c:50	CKD139	a:23 b:40 c:30

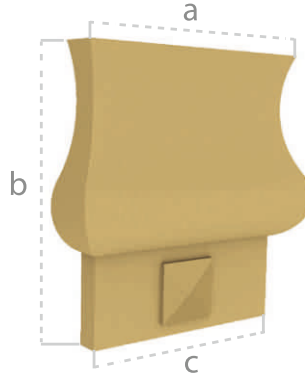

CKD 19	a:40 b:35 c:33	CKD 32	a:60 b:35 c:53
CKD 31	a:50 b:35 c:43	Wordt met een dikte van 7 cm geproduceerd	

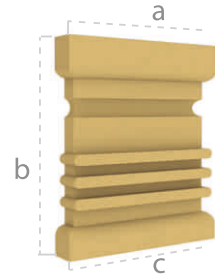

CKD 66	a:32 b:30 c:32	CKD 68	a:52 b:30 c:52
CKD 67	a:42 b:30 c:42	CKD136	a:22 b:30 c:22

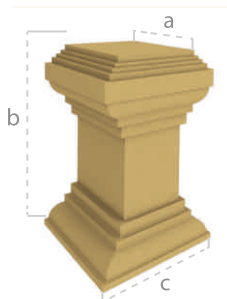

CKD 51	a:22 b:50 c:32	CKD 53	a:42 b:100 c:52
CKD 52	a:32 b:80 c:42		

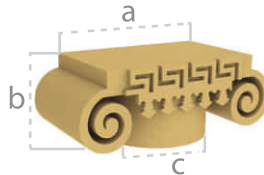

CKD 72	a:54 b:19,5 c:22	CKD 74	a:103 b:37,5 c:42
CKD 73	a:78,5 b:28,5 c:32		

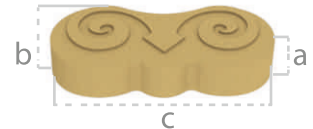

CKD 55	a:14 b:20 c:35	CKD 56	a:18 b:25 c:45
CKD 54	a:10 b:15 c:25		

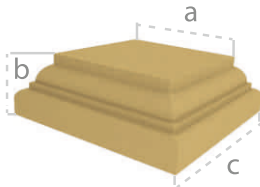

CKD 58	a:42 b:15 c:55	CKD 59	a:52 b:15 c:65
CKD 57	a:32 b:15 c:45		

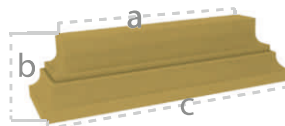

CKD 60	a:30 b:15 c:42	CKD 62	a:50 b:15 c:62
CKD 61	a:40 b:15 c:52		





CPY 01

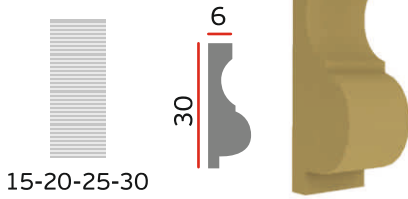

15-20-25-30

CPY 06

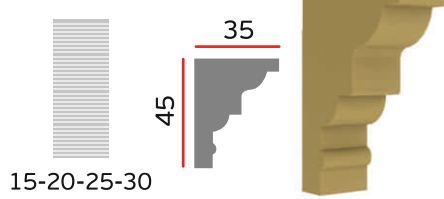

15-20-25-30

CPY 11

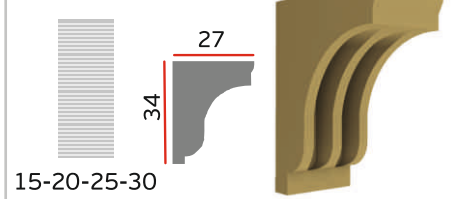

15-20-25-30

CPY 02

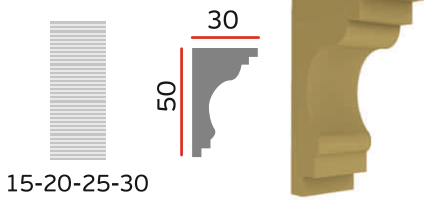

15-20-25-30

CPY 07

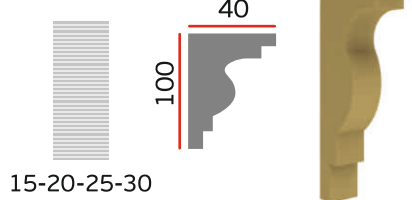

15-20-25-30

CPY 12

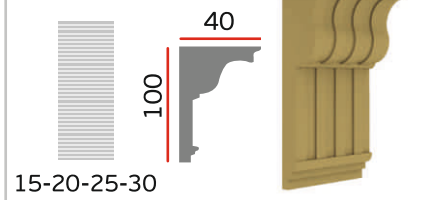

15-20-25-30

CPY 03

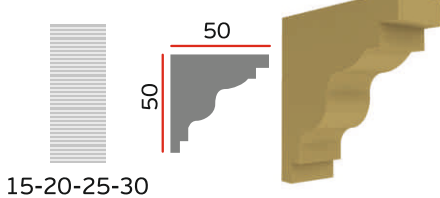

15-20-25-30

CPY 08

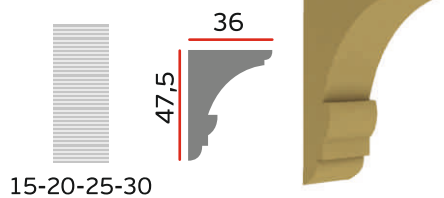

15-20-25-30

CPY 13

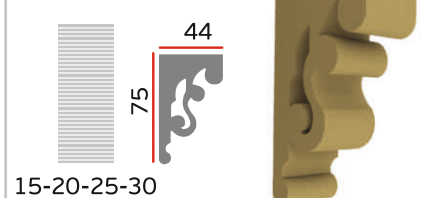

15-20-25-30

CPY 04

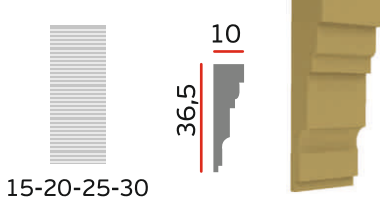

15-20-25-30

CPY 09

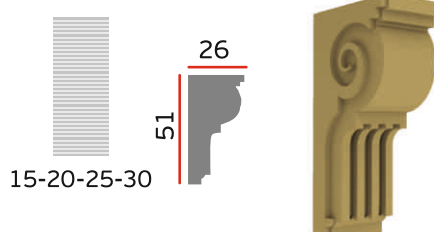

15-20-25-30

CPY 14

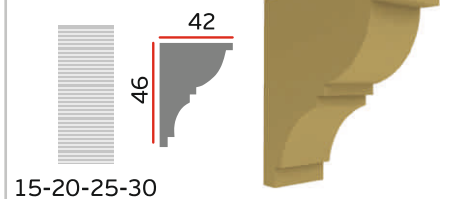

15-20-25-30

CPY 05

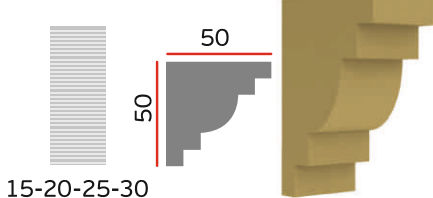

15-20-25-30

CPY 10

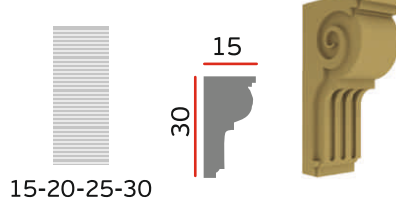

15-20-25-30

CPY 17

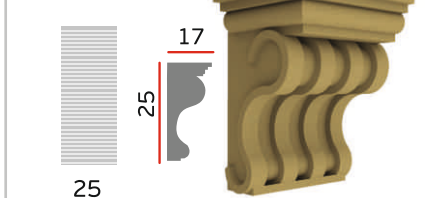

25

CPY 18

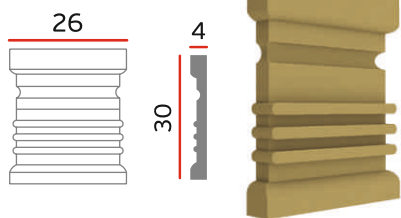

CPY 21

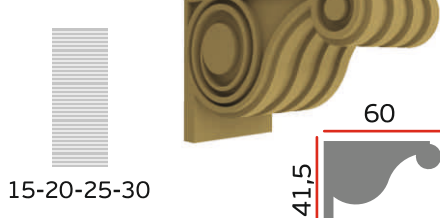

CPY 24

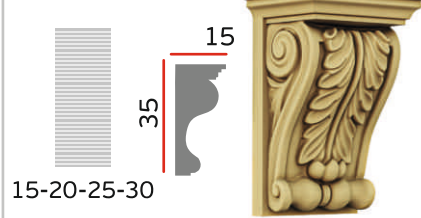

CPY 19

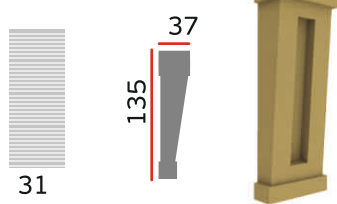

CPY 22

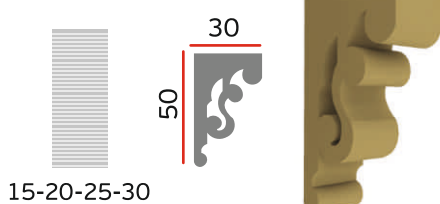

CPY 25

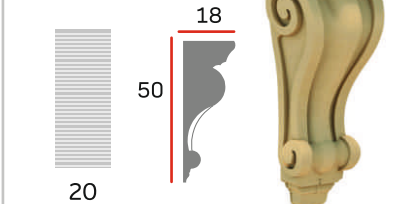

CPY 20

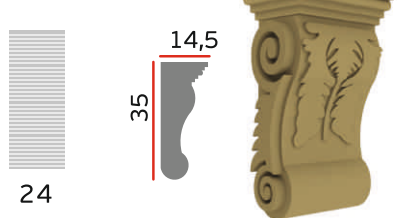

CPY 23

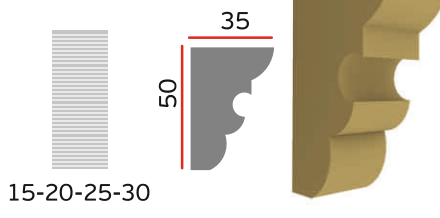

CPY 26

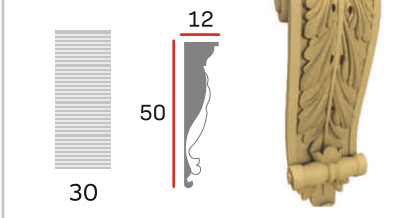

CPY 27

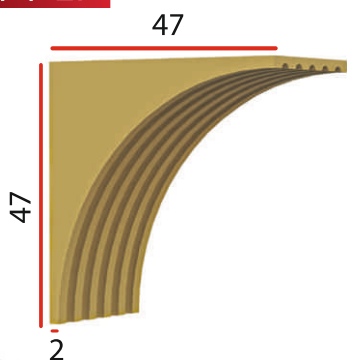

CPY 28

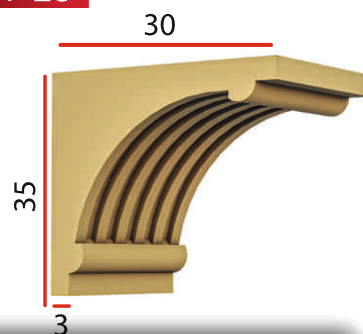

These products can be used together with CSV69 making an arch construction.

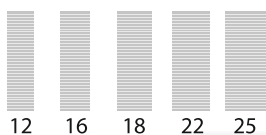

Especially
designed for
YOU



CKT 01

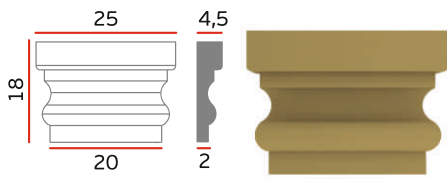

CKT 07

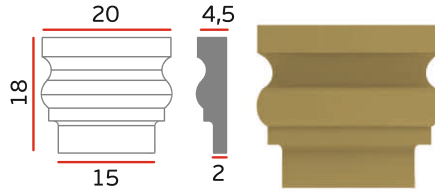

CKT 14

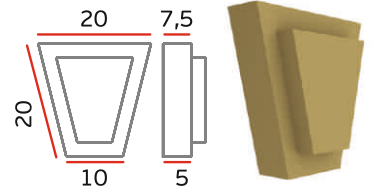

CKT 02

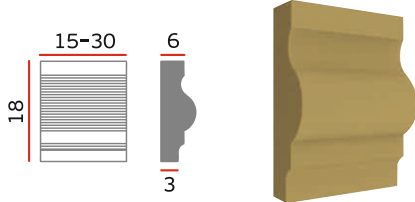

Also produced in 30 cm

CKT 08

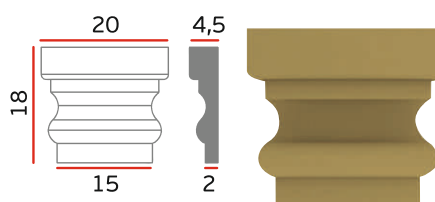

CKT 15

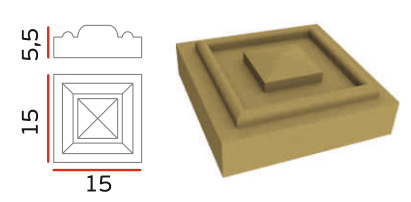

CKT 03

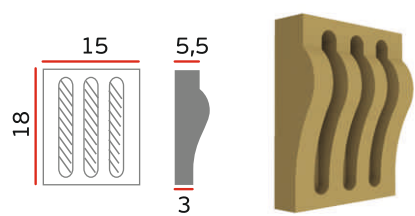

CKT 09

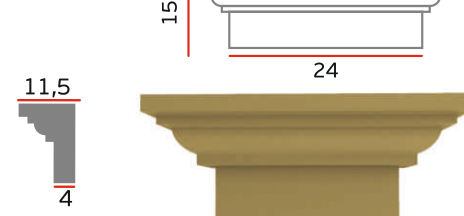

CKT 16

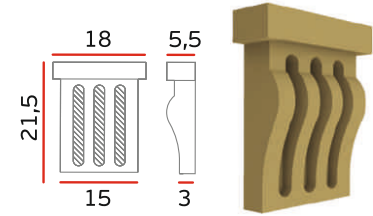

CKT 04

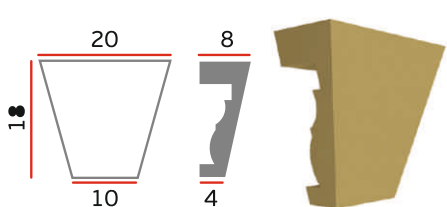

The product for which it is to be used must be specified.

CKT 10

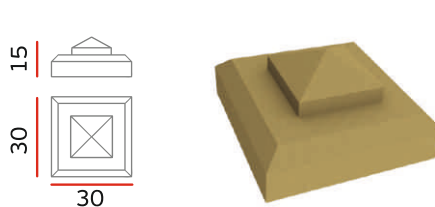

CKT 17

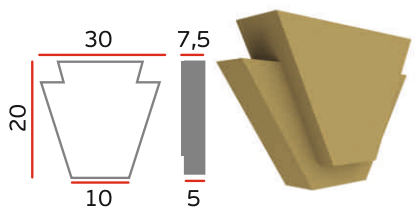

CKT 05

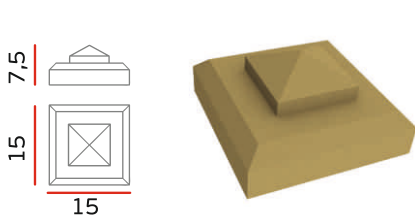

CKT 13

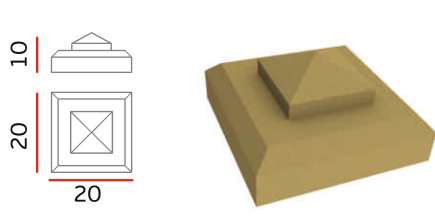

CKT 18

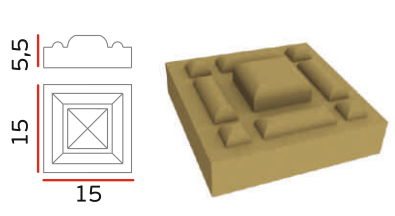

CKT 06

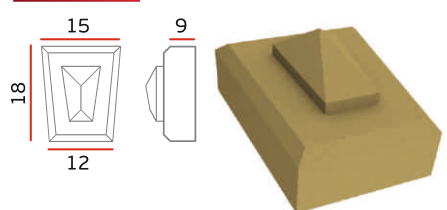

CKT 19

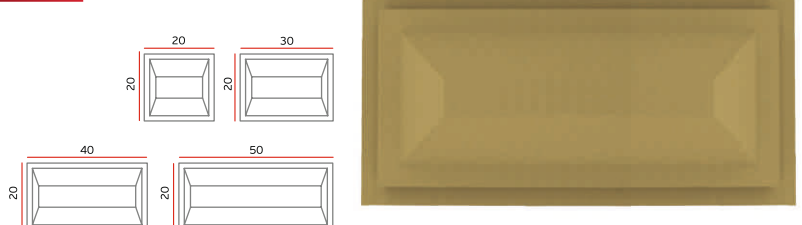



CRZ01



50x50x7,5 cm

CRZ02



50x50x5 cm

CRZ03



50x50x5 cm

CRZ04



50x50x6 cm

CRZ05



50x50x6 cm

CRZ06



50x50x7,5 cm

CRZ07



75x75x5 cm

CRZ08



50x50x6 cm

CAD01



20x19x3 cm

CAD02



29x29x3 cm

CAD03



15x9x3 cm

CBS01



63x30x3 cm

CBS02



50x31x3 cm

CBS03



35x33x3 cm

CBS04

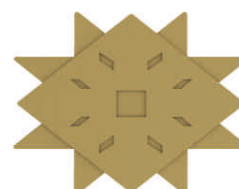

50x50x3 cm

CBS 05

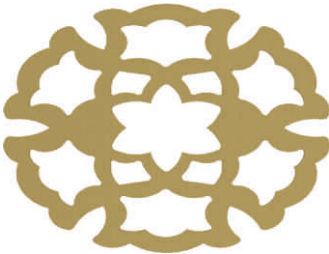

50x50x3 cm

CBS 06



42x20x3 cm

CYD 02



25x14x3 cm

CYD 03



25x14x3 cm

CPKD 01



32,5x32,5x3 cm

CPKD 02



32,5x32,5x3 cm

CMTF 01



50x50x3 cm

CMTF 02

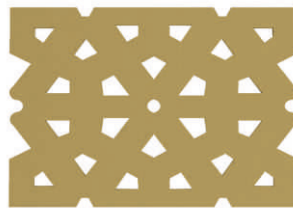

80x70x3 cm

CMTF 03



100x50x3 cm

CMTF 04



50x32x3 cm

CMTF 05



56x56x3 cm

CMTF 06



100x50x3 cm

CMTF 07



100x50x3 cm

CMTF 08



50x100x5 cm

CMTF 09



50x100x4 cm

CMTF 10

50x100x4 cm



CMTF 11

50x100x5 cm



CMTF 13

50x50x3 cm

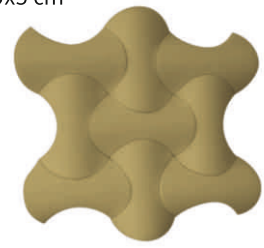

CMTF 14

42x150x5 cm



CMTF 15

43x100x4 cm



CMTF 16

43x100x5 cm



CMTF 17

50x50x5 cm



CMTF 18

50x50x3 cm



CMTF 19

50x50x4 cm

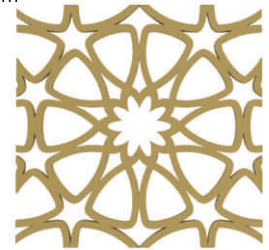

CMTF 20

35x75x5 cm



CMTF 21

50x50x4 cm



CMTF 23

50x50x5 cm

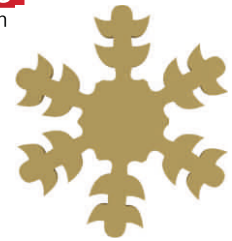

CMTF 24

50x50x4 cm



CMTF 25

50x50x4 cm

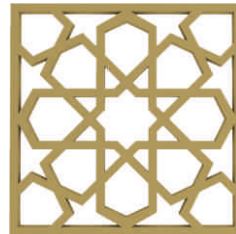

CMTF 26

50x50x4 cm



CMTF 27

80x98,5x4 cm



CMTF 28

50x100x4 cm



CMTF 30

50x50x5 cm

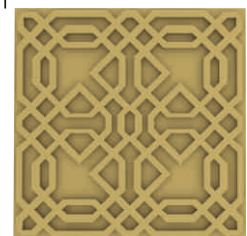

CMTF 31



100x100x5 cm

CMTF 32



100x100x8 cm
120x120x8 cm

CMTF 33



100x100x4 cm

CPKD34



3x50x50 cm



Empire

DECORATIONS

- Four meters of convenience
- Flexibel structure
- Easy to apply
- Fire-retardant

- Cuatro metros de comodidad
- Estructura flexible
- Fácil de aplicar
- Ignífugo

- Vier meter aan gemak
- Flexibele structuur
- Eenvoudig te monteren
- Vuurvertragend



4

METERS OF PERFECT MATERIAL

METROS DE MATERIAL PERFECTO

METER AAN PERFECT MATERIAAL

4 metre

We've engineered our technology to enable the production of all our outdoor products in lengths of up to 4 meters. This innovation allows for seamless assembly of these pieces without the need for any additional components. Due to our products being crafted from flexible raw materials, there is no risk of structural fractures within the component.

Hemos diseñado nuestra tecnología para permitir la producción de todos nuestros productos para exteriores en longitudes de hasta 4 metros. Esta innovación permite el montaje sin problemas de estas piezas sin necesidad de componentes adicionales.

Debido a que nuestros productos están fabricados con materiales crudos flexibles, no hay riesgo de fracturas estructurales dentro del componente.

We hebben onze technologie ontwikkeld om al onze buitenproducten te kunnen produceren in lengtes tot wel 4 meter. Deze innovatie maakt het mogelijk om deze stukken naadloos in elkaar te zetten zonder de noodzaak van extra onderdelen. Vanwege het feit dat onze producten vervaardigd zijn uit buigzame grondstoffen, is er geen risico op structurele breuken binnen het onderdeel.



CFG 01



CFG 06



CFG 02

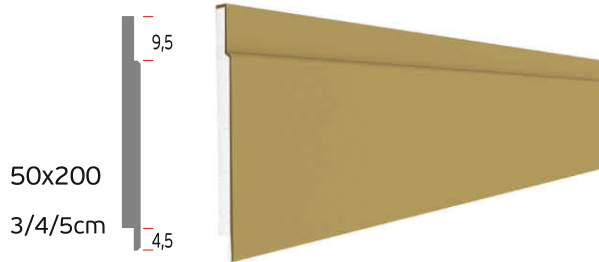

CFG 09

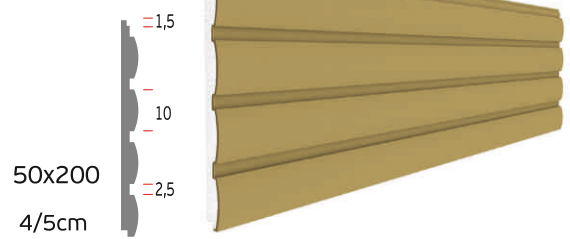

CFG 03



CFG 10

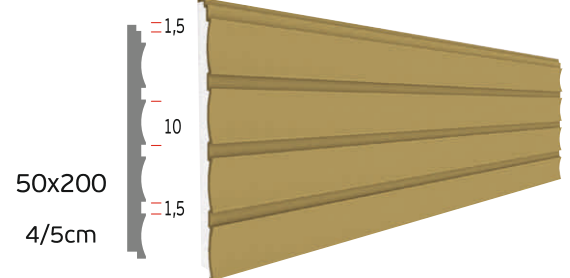

CFG 04

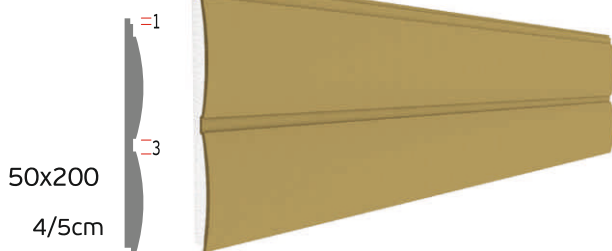

CFG 51

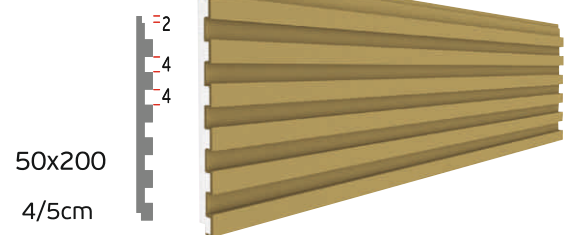

CFG 05



CFG 52

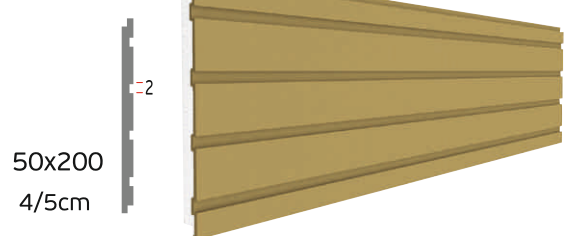

CFG12

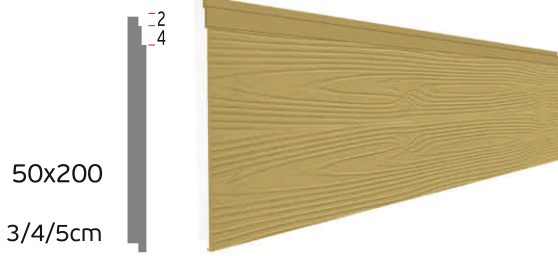

CFG17

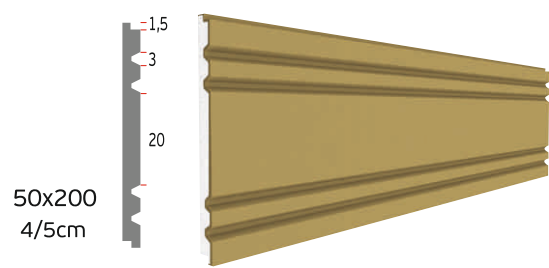

CFG13

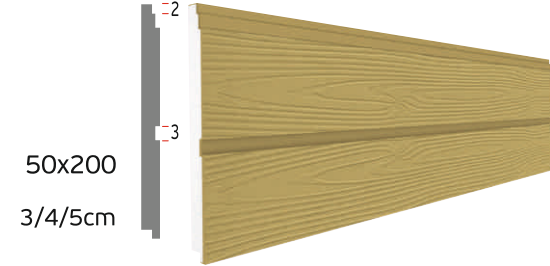

CFG64

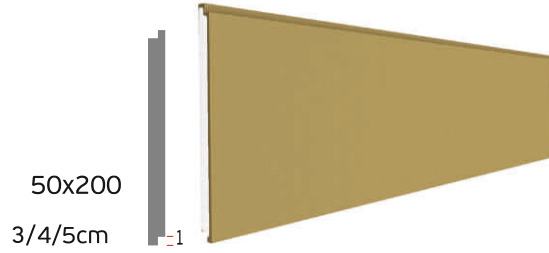

CFG19

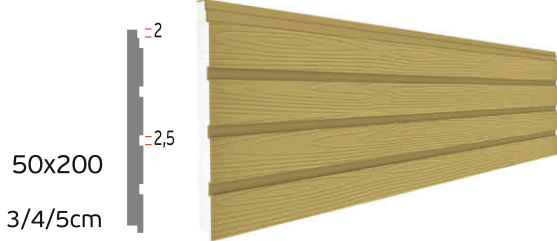

CFG65

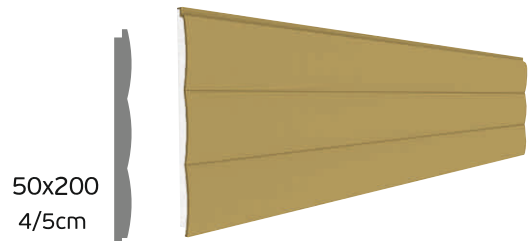

CFG20

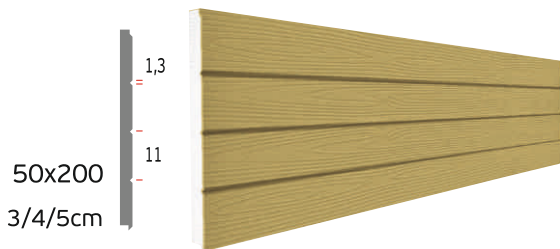

CFG21

70x200cm

CFG23

50x50cm



*Composite Look

Empire

DECORATIONS

Product can be
manufactured in your
desired coating and EPS
thickness



CFG 08

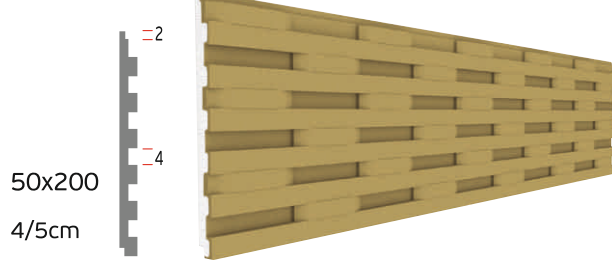

CFG 63

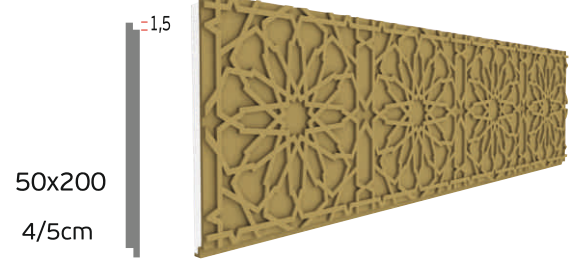

CFG 14

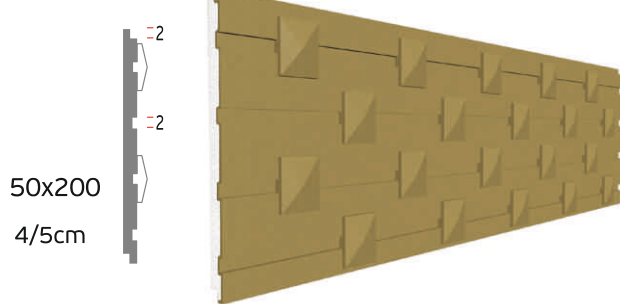

CFG 50

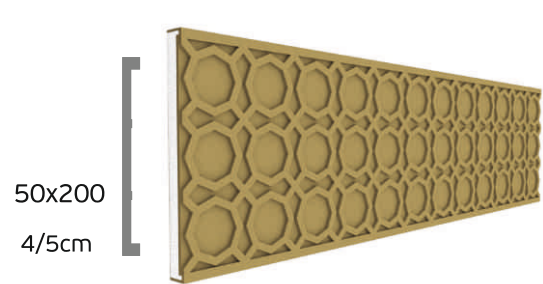

CFG 15



CFG 78



CFG 16



CFG 40

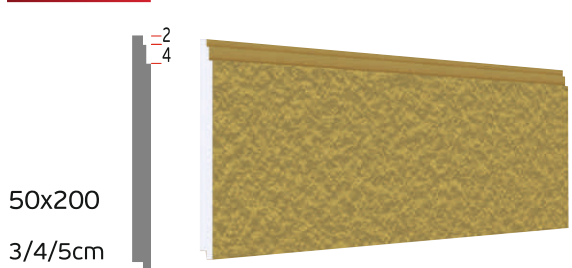

CFG 77



CFG 62

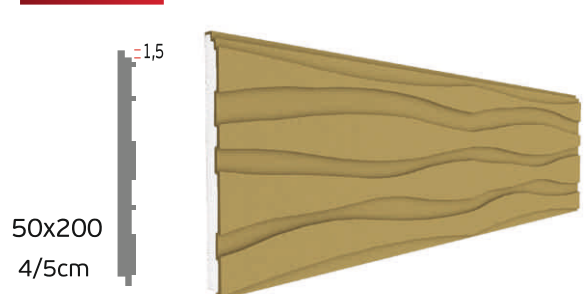

Production can be manufactured in your desired coating and EPS thickness.

CFG 69

50x200
4 cm

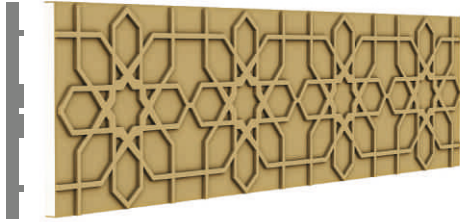

CFG 74

50x200
5 cm

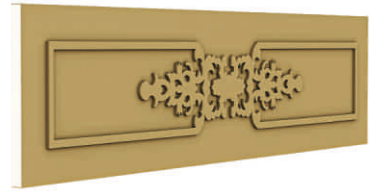

CFG 70

50x200
4 cm



CFG 75

50x200
4 cm



CFG 71

50x200
4 cm



*Composiet uitstraling

CFG 76

50x200
4 cm

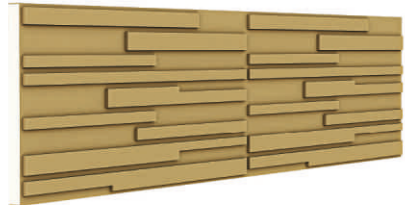

CFG 72

50x200
6,5 cm



CFG 79

50x200
5 cm



CFG 73

50x200
5 cm



CFG 80

50x200
3,5 cm



Production can be manufactured in your
desired coating and EPS thickness

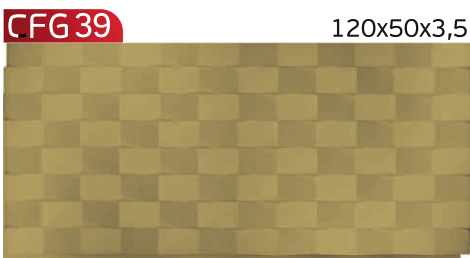
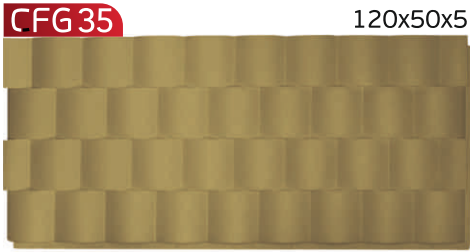

Production can be manufactured in your
desired coating and EPS thickness.



CTGK 01



CTGK 04

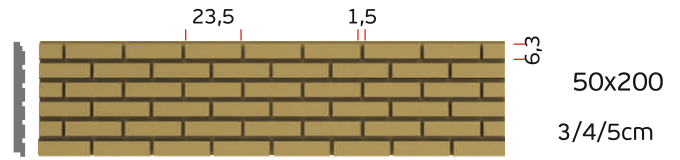

CTGK 02



CTGK 07

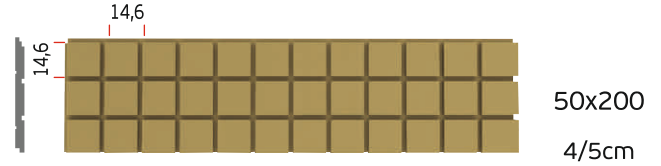

CTGK 03

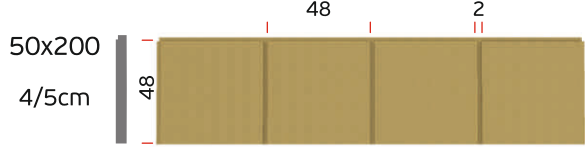

CTGK 09

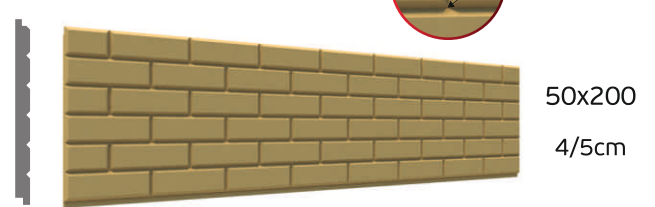

CYB 01

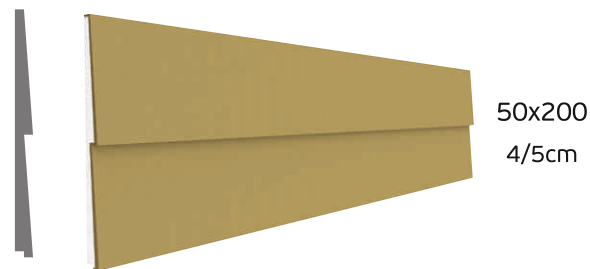

CYB 02

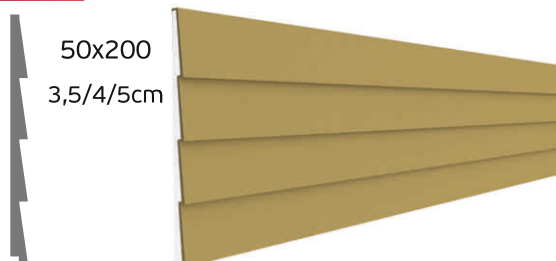

CYB 03

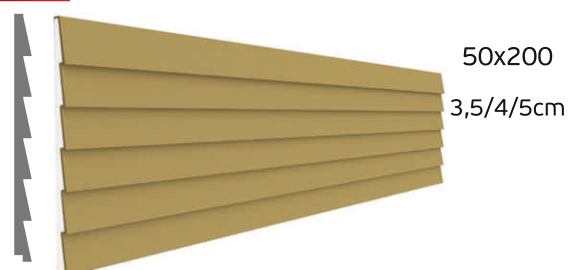





CYRD 10

Mounting Adhesive
for Interior
Adhesivo de montaje para
interiores



CYRD 05

Polyurethane (PU)
Adhesive Foam
Espuma Adhesiva
de Poliuretano (PU)



CYRD 01



5 kg

Repair Mortar
Mortero de Reparación
Reparatie Mortel

CYRD 01



10 kg

Repair Mortar
Mortero de Reparación
Reparatie Mortel

CYRD 02

Thermal Insulation
Board Adhesive
Adhesivo para Placas de
Aislamiento Térmico
Lijm voor Thermische
Isolatieplaten



25 kg

CYRD 06



Gun spray-cleaner
Spray limpiador
Pistoolreiniger

CYRD 07



Spray-gun
Pistola
Spray-Pistool



White EPS insulation board



Carbon EPS insulation board

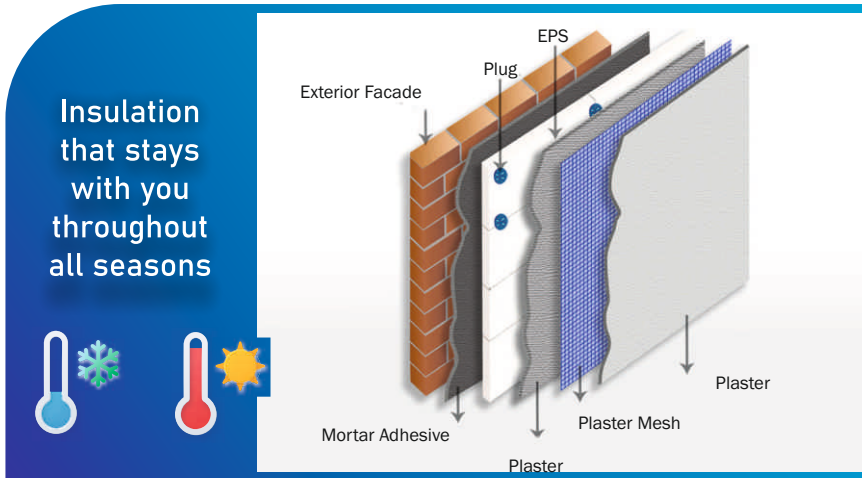

Dimensions Insulation package	Afmeting Size	Aantal Amount	Verpakking Packaging m ²	Verpakking Packaging m ²	1 m ³ = m ²
	3x50x100 cm	16 Ad.	8,00 m ²	0,24 m ²	33,33 m ²
	4x50x100 cm	12 Ad.	6,00 m ²	0,24 m ²	25 m ²
	5x50x100 cm	10 Ad.	5,00 m ²	0,25 m ²	20 m ²
	6x50x100 cm	8 Ad.	4,00 m ²	0,24 m ²	16,67 m ²
	7x50x100 cm	7 Ad.	3,50 m ²	0,245 m ²	14,29 m ²

Contents Insulation Package	Products	Amount
	EPS	50x100
	Mortar Adhesive	4,5 kg m ²
	Plaster Mortar	4,5 kg m ²
	Decorative Plaster Mortar	2,5 kg m ²
	Plaster Mesh	160 gr (1,12 mt/m ²)
	Insulation Plug	10-12cm (6m ² /ad)
Corner profile	0,25 mt/ m ²	

CYRD 14

Insulation Plug



10x12 cm

CYRD 11



Plaster Mortar

CYRD 08



Decorative Plaster Mortar

CYRD 16



Plaster Mesh

CYRD 17

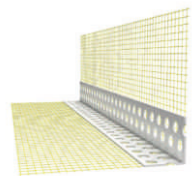

Corner profile with PVC mesh





Window Model 1



Window Model 2



Window Model 3



Window Model 4

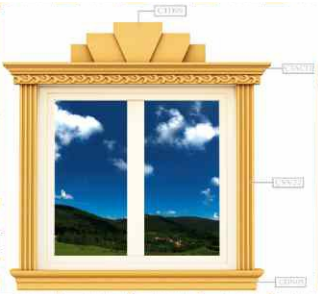

Window Model 5



Window Model 6



Window Model 7

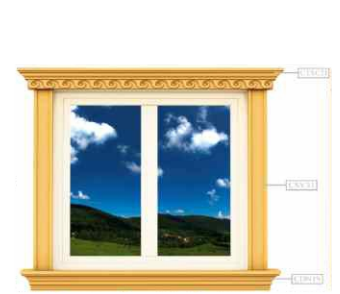

Window Model 8

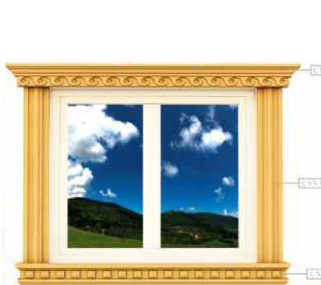

Window Model 9

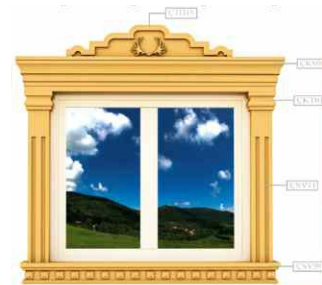

Window Model 10



Window Model 11

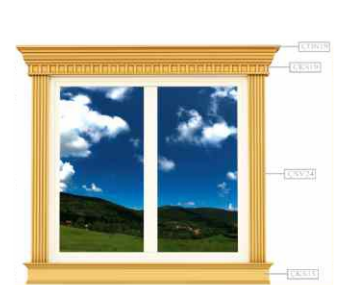

Window Model 12



Window Model 13



Window Model 14



Window Model 15



Window Model 16



Window Model 17



Window Model 18



Window Model 19

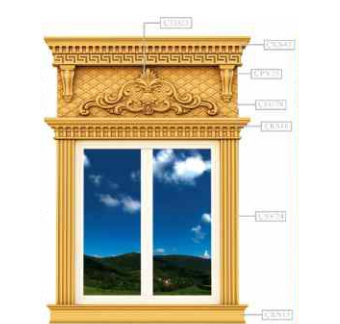

Window Model 20



Model 1



Model 2



Model 3



Model 4



Model 5



Model 6



Model 7



Model 8



Model 9



Model 10



Model 11



Model 12



Model 13



Model 14



Model 15

Feel free to take a look at
our website to get to know
more about us!

Siéntase libre de visitar
nuestro sitio web para
conocer más sobre
nosotros!



www.empire-decorations.com



Certification

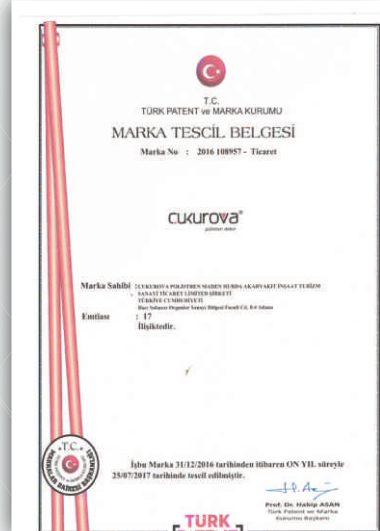
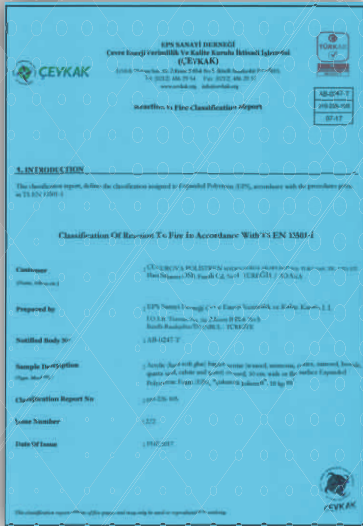

Empire

DECORATIONS



+31 (0) 6 831 333 64

info@empire-decorations.com

www.empire-decorations.com

Aruba

  /empire.decorations

Feel free to contact us if you have any questions.